

Tender Documents

HCL File # 24735
PRJ#26009

Burton Water System – Water Main Replacement (Ph 2), Burton, BC



HIGHLAND CONSULTING LTD
CIVIL ENGINEERING

Prepared By:
Highland Consulting Ltd.
614 Josephine St.
Nelson, BC
V1L 1W7

March 2026

TABLE OF CONTENTS

- Invitation to Tender
- Instructions to Tenderers, Part 1
- Form of Tender
 - Appendix 1 – Schedule of Quantities and Prices
 - Appendix 2 – Preliminary Construction Schedule
 - Appendix 3 – Experience of Superintendent
 - Appendix 4 – Comparable Work Experience
 - Appendix 5 – Subcontractors
- Form of Agreement
- Supplementary General Conditions
- Supplementary Specifications
- Appendices:
 - Contract Drawings

The following Standard Documents are not included, but referred to as part of the Tender Documents (available in “2019 MMCD Edition”)

- Instructions to Tenderers, Part II
- General Conditions
- Schedules and Diagrams
 - Schedule 17.5.3 – Letter Agreement with Referee
 - Flow Chart – changes and Extra Work
 - Flow Chart – Dispute Resolution Process
- Standard Specifications
- Standard Detail Drawings

Invitation to Tender



HIGHLAND CONSULTING LTD
CIVIL ENGINEERING

INVITATION TO TENDERERS

Owner: Regional District of Central Kootenay
(NAME OF OWNER)

Contract: Burton Water System – Water Main Replacement (Ph 2)
(TITLE OF CONTRACT)

Reference No. PRJ#26009
(OWNER'S CONTRACT REFERENCE NO.)

The Owner invites tenders for: Installation of 233m of 150mm Dia. C900 PVC watermain, with associated service connections, fixtures, and tie-ins.
(BRIEF DESCRIPTION OF THE WORK)

the Contract Documents are available for viewing at: www.rdck.ca or www.bcbid.gov.bc.ca

Tenderers to obtain their own copy via the websites listed above.
(ADDRESS WHERE CONTRACT DOCUMENTS CAN BE VIEWED)

Tenders are scheduled to close:

Tender Closing Time: 2 : 00 , p m local time

Tender Closing Date: April 22nd , 20 26

Address: Regional District of Central Kootenay
Box 590, 202 Lakeside Drive
Nelson, BC V1L 5R4

(ADDRESS)

Refer to IT3.0 for submission methods

NAME OF OWNER'S REPRESENTATIVE Highland Consulting Ltd.

250-551-1416
(PHONE)

Instruction to Tender



HIGHLAND CONSULTING LTD
CIVIL ENGINEERING

1.0 Introduction.....IT - 1

2.0 Tender DocumentsIT - 1

3.0 Submission of TendersIT - 2

4.0 Additional Instructions to Tenderers.....IT - 3

THIS PAGE INTENTIONALLY LEFT BLANK

(FOR USE WHEN UNIT PRICES FORM THE BASIS OF PAYMENT TO BE USED ONLY WITH THE GENERAL CONDITIONS AND OTHER STANDARD DOCUMENTS OF THE UNIT PRICE MASTER MUNICIPAL CONSTRUCTION DOCUMENTS.)

(TO BE READ WITH “INSTRUCTIONS TO TENDERERS - PART II”
CONTAINED IN THE EDITION OF THE PUBLICATION
“MASTER MUNICIPAL CONSTRUCTION DOCUMENTS” SPECIFIED IN ARTICLE 2.2 BELOW)

Owner: Regional District of Central Kootenay
(NAME OF OWNER)

Contract: Burton Water System – Water Main Replacement (Ph 2)
(TITLE OF CONTRACT)

Reference No. PRJ#26009
(OWNER'S CONTRACT REFERENCE NO.)

1.0 Introduction

1.1 These Instructions apply to and govern the preparation of tenders for this *Contract*. The *Contract* is generally for the following work:

1. Supply and Installation of 233 meters of new 150 mm C900 PVC
2. Supply and Installation of (5) service connections
3. Supply and Installation of associated fixtures and tie-ins

(BRIEF DESCRIPTION OF THE WORK)

1.2 Direct all inquiries regarding the *Contract*, to:

Cooper Husband, P.Eng.

Civil Engineer

(NAME AND POSITION OF INDIVIDUAL WHO WILL ANSWER INQUIRIS)

Address: 614 Josephine St.
Nelson, BC V1L 1W7

Phone: 250 - 254 - 6952

Email: chusband@highlandconsultingltd.com

2.0 Tender Documents

2.1 The tender documents which a tenderer should review to prepare a tender consist of all of the *Contract Documents* listed in Schedule 1 entitled “Schedule of Contract Documents”. Schedule 1 is attached to the Agreement which is included as part of the tender package. The *Contract Documents* include the drawings listed in Schedule 2 to the Agreement, entitled “List of *Contract Drawings*”.

2.2 A portion of the *Contract Documents* are included by reference. Copies of these documents have not been included with the tender package. These documents are the Instructions to Tenderers - Part II, General Conditions, Specifications and Standard Detail

Drawings. They are those contained in the publication entitled “Master Municipal Construction Documents - General Conditions, Specifications and Standard Detail Drawings”. Refer to Schedule 1 to the Agreement or, if not specified in Schedule 1, then the applicable edition shall be the most recent edition as of the date of the *Tender Closing Date*. All sections of this publication are by reference included in the *Contract Documents*.

- 2.3 Any additional information made available to tenderers prior to the *Tender Closing Time* by the *Owner* or representative of the *Owner*, such as geotechnical reports or as-built plans, which is not expressly included in Schedule 1 or Schedule 2 to the Agreement, is not included in the *Contract Documents*. Such additional information is made available only for the assistance of tenderers who must make their own judgment about its reliability, accuracy, completeness and relevance to the *Contract*, and neither the *Owner* nor any representative of the *Owner* gives any guarantee or representation that the additional information is reliable, accurate, complete or relevant.

3.0 Submission of Tenders

- 3.1 Tenders must be submitted utilizing one of the submission methods below, on or before:

Tender Closing Time: 2 : 00 , p m local time
Tender Closing Date: April 22nd , 20 26

- 3.1.1 Electronic submission to

Email: tenders@rdck.bc.ca.

Tenderers shall ensure that all required documents are included in their submission and that their submission is less than 15MB (maximum RDCK file size allowed on server). A confirmation email will be sent confirming receipt of submission.

- 3.2 Late tenders will not be accepted or considered, and will not be opened.

4.0 Additional Instructions to Tenderers

4.1 **Owner's Rights**

The *Owner* holds certain rights, including:

- The ability to cancel the tendering process at any time, without explanation or the obligation to provide compensation for damages.
- The discretion to select a *Contractor* based on factors such as quality, service, and price, in order to achieve the greatest value.
- The authority to accept or reject a tender from a tenderer who has been in litigation, arbitration, or mediation with the *Owner* and/or its agents, either currently or in the past.
- The right to terminate the tender process if only one tender is received.
- The option to extend the *Tender Closing Date* by addendum for any reason, with the extended date and/or time becoming the new deadline.
- The lowest or any tender will not necessarily be accepted and the *Owner* may reject any and all tenders.
- The *Contract* will be established if and when the successful tenderer receives from the *Owner* a written notification accepting the tender without any conditions. If the *Owner's* written notification accepting the tender contains, or is subject to, any conditions, the *Contract* will be established if and when the tenderer accepts all such conditions in writing or when the parties execute the agreement.
- If the lowest compliant tender exceeds the *Owner's* budget, and the *Owner* is unwilling or unable to award a contract at the tender price, the *Owner* may:
 - (i) negotiate, with the lowest compliant tenderer only, changes to the tender documents and a reduced tender price acceptable to the *Owner*, or
 - (ii) invite the three lowest compliant tenderers (only) to re-bid on modified tender documents under a new tender call.

4.2 **Pre-Tender Meeting**

A pre-tender meeting may be held on **April 9, 2026, at 12:30 PM** at the project location on **Burton Main Rd and Burton Cross Rd**. Attendance is optional, and the purpose of the meeting is to allow prospective bidders to ask questions related to the tender. Representatives from the design team and the *Owner* will be present to provide answers and clarifications as necessary.

4.3 Site Access

The site can be reached via Highway 6 and Burton Main Rd.

4.4 Inquiries, Clarifications, and Addenda

Any inquiries regarding this tender must be submitted in writing to the contact listed in Section 1.2 of the Instructions To Tenderers Part I, no later than 5 business days before the *Tender Closing Date*.

If deemed necessary by the Regional District of Central Kootenay, responses to inquiries and any revisions to the tender will be communicated through addenda, which will be posted on the same public notice board as this call for tenders. It is the sole responsibility of the tenderer to periodically check the tender site for addenda. By submitting a tender in response to this call, the bidder acknowledges having received, reviewed, and taken into account all addenda issued in relation to this tender. The bidder must not rely on any clarifications, comments, revisions, or other information obtained from any other source, as they are not authorized.

4.5 Conflict of Interest

Tenderers must disclose any potential conflict of interest or existing business relationships that they may have with the Regional District of Central Kootenay, its elected officials, or employees.

4.6 Award of Contract

The Regional District of Central Kootenay may only award this Contract if there are sufficient funds available to complete the Work. The Regional District of Central Kootenay reserves the right, through addenda issued prior to award, to modify the Work to align with the funding made available for the project outlined in these tender documents.

4.7 Replace paragraph 5.3.4 of the Instructions to Tenderers – Part II with:

Tenderers shall provide a list of previous comparable work, including a brief description of that work, approximate contract value, and a minimum of three references complete with current contact details and phone numbers.

4.8 Form of Tender Security

Scanned copies of the tender security ("*Bid Security*") are sufficient for electronic submission of Tenders.

4.9 Tenderer's Acknowledgment of Contract Documents

Tenderer's are advised that the Supplemental General Conditions and Supplemental Specifications contain requirements related to, but not limited to:

- Traffic Management
- Pre-Work Site Inspection
- Pre-Mobilization Tie-In Locates
- Disposal of Waste Material
- Surface Feature Protection
- Owner's retention of temporary water piping
- Insurance

Tenderer's are advised to include all costs associated with these requirements in their bid. Payment for these requirements is considered incidental to payment for work described in other Sections unless shown otherwise in the *Schedule of Quantities and Prices*.

4.10 Owner-Supplied Materials

The *Owner* will supply certain materials, as specified in the *Schedule of Quantities and Prices*. Refer to Supplementary General Condition 4.9.3 for additional requirements.

A list of *Owner*-supplied materials is provided below for reference only. In the event of any discrepancy between this list and the *Schedule of Quantities and Prices*, the *Schedule of Quantities and Prices* shall govern.

- PVC C900 DR18 150mm diameter – (233m)

Only those materials listed shall be supplied by the *Owner*. The Contractor shall supply all other materials required to complete the Work, including, without limitation, fittings, appurtenances, bedding, backfill, tracer wire, joint protection, and restraints.

4.11 Tender Security

A tender must be accompanied by tender security ("*Bid Security*") as required under section 5.2 of the Instructions to Tenderers – Part II.

Forms of the tender security that are satisfactory to the owner include:

- irrevocable letter of credit;
- certified cheque;
- bank draft.

The tender security shall be in an amount equal to 10% of the *Tender Price* as required under section 5.2 of the Instructions to Tenderers – Part II.

The certified cheque or bank draft shall be in favour of the Regional District of Central Kootenay.

Tender securities will be returned to all unsuccessful tenderers once a service contract has been formalized with the selected tenderer.

4.12 Contract Award Timing

A recommendation for award of the *Contract* is anticipated to be presented at the *Owner's* board meeting scheduled for May 21, 2026.

Form of Tender



HIGHLAND CONSULTING LTD
CIVIL ENGINEERING

FORM OF TENDER

- WE CONFIRM:** 3.1 that we understand and agree that the quantities as listed in the *Schedule of Quantities and Prices* are estimated, and that the actual quantities will vary.
- WE CONFIRM:** 4.1 that the following appendices are attached to and form a part of this tender:
- 4.1.1 the appendices as required by paragraph 5.3 of the Instructions to Tenderers – Part II; and
 - 4.1.2 the *Bid Security* as required by paragraph 5.2 of the Instructions to Tenderers – Part II.
- WE AGREE:** 5.1 that this tender will be irrevocable and open for acceptance by the *Owner* for a period of **45** calendar days from the day following the *Tender Closing Date and Time*, even if the tender of another tenderer is accepted by the *Owner*. If within this period the *Owner* delivers a written notice ("*Notice of Award*") by which the *Owner* accepts our tender we will:
- 5.1.1 within 15 *Days* of receipt of the written *Notice of Award* deliver to the *Owner*:
 - .1 a Performance Bond and a Labour and Material Payment Bond, each in the amount of 50% of the Contract Price, covering the performance of the Work including the Contractor's obligations during the Maintenance Period, issued by a surety licensed to carry on the business of suretyship in the province of British Columbia, and in a form acceptable to the *Owner*;
 - .2 a Baseline Construction Schedule, as provided by GC 4.6.1;
 - .3 a "clearance letter" indicating that the tenderer is in Worksafe BC compliance; and
 - .4 a copy of the insurance policies as specified in GC 24 indicating that all such insurance coverage is in place and;
 - 5.1.2 within 2 *Days* of receipt of written "*Notice to Proceed*", or such longer time as may be otherwise specified in the *Notice to Proceed*, commence the *Work*; and
 - 5.1.3 sign the Contract Documents as required by GC 2.1.2.

FORM OF TENDER

WE AGREE:

- 6.1 that, if we receive written *Notice of Award* of this *Contract* and, contrary to paragraph 5 of this Form of Tender, we:
- 6.1.1 fail or refuse to deliver the documents as specified by paragraph 5.1.1 of this Form of Tender; or
 - 6.1.2 fail or refuse to commence the *Work* as required by the *Notice to Proceed*,
then such failure or refusal will be deemed to be a refusal by us to enter into the *Contract* and the *Owner* may, on written notice to us, award the *Contract* to another party. We further agree that, as full compensation on account of damages suffered by the *Owner* because of such failure or refusal, the *Bid Security* shall be forfeited to the *Owner*, in an amount equal to the lesser of:
 - 6.1.3 the face value of the *Bid Security*; and
 - 6.1.4 the amount by which our *Tender Price* is less than the amount for which the *Owner* contracts with another party to perform the *Work*.

**OUR ADDRESS IS AS
FOLLOWS:**

Phone: _____

Fax: _____

Attention: _____

This Tender is executed this
_____ day of _____, 20 _____.

Contractor:

(FULL LEGAL NAME OF CORPORATION, PARTNERSHIP OR INDIVIDUAL)

(AUTHORIZED SIGNATORY)

(AUTHORIZED SIGNATORY)

(See paragraph 5.3.1 of the Instructions to Tenderers – Part II)

All prices and Quotations including the Contract Price shall include all Taxes, but shall not include GST. GST shall be shown separately.

Summary Sheet:

Division 01 – General \$ _____

Division 31 – Earthworks \$ _____

Division 32 – Roads and Site Improvements \$ _____

Division 33 – Utilities \$ _____

Optional Work \$ _____

TENDER PRICE \$ _____

GST @ 5% \$ _____

Reference No.	Section	Paragraph	Item Description	Unit	Quantity	Unit Price	Amount
Division 01 - General Requirements							
			Temporary Watermain HDPE DR17 50mm diameter temporary overland connection Parts to be retained by RDCK following construction <i>Includes supply, installation, and removal</i> <i>Includes temporary double check valve, disinfection, flushing, testing, advisories, and all related fittings and appurtenances</i>				
01-1	01 51 01	1.6.1		lump sum	1		\$ -
01-2	01 53 01	1.9.2	Mobilization / Demobilization	lump sum	1		\$ -
			Traffic Management Plan (TMP) <i>includes preparation, submittal and approval of TMP</i> <i>includes Lane Closure Request if required</i>				
01-3	01 55 00	1.5.1		lump sum	1		\$ -
01-4	01 55 00	1.5.1	Implementation of TMP, Traffic Control, Vehicle Access and Parking	lump sum	1		\$ -
Sub-Total - Division 01							\$0.00
Division 31 - Earthworks							
31-1	31 22 16	1.4.1	Reinstate Driveways (granular)	ea.	3		\$ -
31-2	31 23 01	1.10.4	Removal and Disposal of AC Pipe	lineal m	233		\$ -
Sub-Total - Division 31							\$0.00
Division 32 - Roads and Site Improvements							
32-1	32 92 19	1.8	Hydraulic Seeding of Disturbed Areas	lump sum	1		\$ -
Sub-Total - Division 32							\$0.00
Division 33 - Utilities							
			Watermain PVC C900 DR18 150mm diameter 1.5m depth, native backfill <i>includes joint protection as indicated on contract drawings</i> <i>includes tracer wire as indicated on contract drawings</i> <i>includes surface restoration and grading, except where paid elsewhere (33-1, 32-1)</i> Owner supplied material: PVC C900 DR18 150mm diameter (233m)				
33-1	33 11 01	1.8.1, 1.8.2		lineal m	233		\$ -
			Gate Valve 150mm HH				
33-2	33 11 01	1.8.3		ea.	1		\$ -
			Bend 150mm diameter 11.25 Degree HH				
33-3	33 11 01	1.8.3		ea.	2		\$ -
			Water Service Connections 19mm diameter munic. poly <i>including saddle, corp stop, curb stop, and all related fittings and appurtenances</i>				
33-4	33 11 01	1.8.4		ea.	4		\$ -
			Water Service Connections 19mm diameter munic. Poly <i>trenchless installation for road crossing</i> <i>including saddle, corp stop, curb stop, and all related fittings and appurtenances</i>				
33-5	33 11 01	1.8.4		ea.	1		\$ -
			Blow-Off Assembly <i>as per contract drawings</i> <i>including tee, restraints, reducing flange, service box, 50mm pipe, thrust block, drain rock, and all related fittings and appurtenances</i>				
33-6	33 11 01	1.8.5		ea.	1		\$ -
			Watermain Tie-In Pipework by Contractor <i>new 150mm to existing 150mm</i> <i>refer to Tie-In Details 1 & 2</i> <i>including Hymax couplings as needed</i>				
33-7	33 11 01	1.8.13		ea.	2		\$ -
Sub-Total - Division 33							\$0.00
Optional Work							
Sub-Total - Optional Work							\$0.00
Subtotal of All Divisions and Optional Work							\$0.00
GST @ 5%							\$0.00
TOTAL TENDER PRICE INCLUDING GST							\$0.00

APPENDIX 3 – EXPERIENCE OF SUPERINTENDENT

Burton Water System – Water Main Replacement (Ph 2)

(TITLE OF CONTRACT)

See paragraph 5.3.3 of the Instructions to Tenderers – Part II.

Name: _____

Experience: _____

Dates: _____

Project Name: _____

Responsibility: _____

References: _____

Dates: _____

Project Name: _____

Responsibility: _____

References: _____

Dates: _____

Project Name: _____

Responsibility: _____

References: _____

Dates: _____

Project Name: _____

Responsibility: _____

References: _____

Tenderer's Initials _____

APPENDIX 4 – COMPARABLE WORK EXPERIENCE

Burton Water System – Water Main Replacement (Ph 2)

(TITLE OF CONTRACT)

PROJECT	OWNER / CONTACT NAME PHONE and FAX	WORK DESCRIPTION	VALUE (\$)
	Owner / Contact _____ Phone () _____ Fax () _____		
	Owner / Contact _____ Phone () _____ Fax () _____		
	Owner / Contact _____ Phone () _____ Fax () _____		
	Owner / Contact _____ Phone () _____ Fax () _____		
	Owner / Contact _____ Phone () _____ Fax () _____		
	Owner / Contact _____ Phone () _____ Fax () _____		
	Owner / Contact _____ Phone () _____ Fax () _____		
	Owner / Contact _____ Phone () _____ Fax () _____		
	Owner / Contact _____ Phone () _____ Fax () _____		
	Owner / Contact _____ Phone () _____ Fax () _____		
	Owner / Contact _____ Phone () _____ Fax () _____		
	Owner / Contact _____ Phone () _____ Fax () _____		
	Owner / Contact _____ Phone () _____ Fax () _____		
	Owner / Contact _____ Phone () _____ Fax () _____		
	Owner / Contact _____ Phone () _____ Fax () _____		

Tenderer's Initials _____

REFERENCE NAME	PHONE	FAX	EMAIL
1)			
2)			
3)			

Tenderer's Initials

Form of Agreement



HIGHLAND CONSULTING LTD
CIVIL ENGINEERING

FORM OF AGREEMENT

(FOR USE WHEN UNIT PRICES FORM THE BASIS OF PAYMENT TO BE USED ONLY WITH THE GENERAL CONDITIONS AND OTHER STANDARD DOCUMENTS OF THE UNIT PRICE MASTER MUNICIPAL CONSTRUCTION DOCUMENTS.)

BETWEEN OWNER AND CONTRACTOR

This agreement made in duplicate this

_____ day of _____, 20____.

Contract:

Burton Water System – Water Main Replacement (Ph 2)

(TITLE OF CONTRACT)

Reference No.

PRJ#26009

(OWNER'S CONTRACT REFERENCE NO.)

BETWEEN:

The The Regional District of Central Kootenay

(NAME OF OWNER)

(the "Owner")

AND:

(NAME AND OFFICE ADDRESS OF CONTRACTOR)

(the "Contractor")

The Owner and the Contractor agree as follows:

**Article 1 The Work
Start /
Completion
Dates**

1.1 The Contractor will perform all Work and provide all labour, equipment and material and do all things strictly as required by the Contract Documents.

1.2 The Contractor will commence the Work in accordance with the Notice to Proceed. The Contractor will proceed with the Work diligently, will perform the Work generally in accordance with the construction schedules as required by the Contract Documents and will achieve Substantial Performance of the Work on or before **October 30, 2026** subject to

(INSERT DATE OF SUBSTANTIAL PERFORMANCE)

the provisions of the Contract Documents for adjustments to the Contract Time.

- 1.3 Time shall be of the essence of the *Contract*.
- Article 2 Contract Documents**
- 2.1 The "*Contract Documents*" consist of the documents listed or referred to in Schedule 1, entitled "Schedule of *Contract Documents*", which is attached and forms a part of this Agreement, and includes any and all additional and amending documents issued in accordance with the provisions of the *Contract Documents*. All of the *Contract Documents* shall constitute the entire *Contract* between the *Owner* and the *Contractor*.
- 2.2 The *Contract* supersedes all prior negotiations, representations or agreements, whether written or oral, and the *Contract* may be amended only in strict accordance with the provisions of the *Contract Documents*.
- Article 3 Contract Price**
- 3.1 The price for the *Work* ("*Contract Price*") shall be the sum in Canadian dollars of the following
- 1.1.1 the product of the actual quantities of the items of *Work* listed in the *Schedule of Quantities and Prices* which are incorporated into or made necessary by the *Work* and the unit prices listed in the *Schedule of Quantities and Prices*; plus
- 1.1.2 all lump sums, if any, as listed in the *Schedule of Quantities and Prices*, for items relating to or incorporated into the *Work*; plus
- 1.1.3 any adjustments, including any payments owing on account of *Changes* and agreed to *Extra Work*, approved in accordance with the provisions of the *Contract Documents*.
- 3.2 The *Contract Price* shall be the entire compensation owing to the *Contractor* for the *Work* and this compensation shall cover and include all profit and all costs of supervision, labour, material, equipment, overhead, financing, and all other costs and expenses whatsoever incurred in performing the *Work*.
- Article 4 Payment**
- 4.1 Subject to applicable legislation and the provisions of the *Contract Documents*, the *Owner* shall make payments to the *Contractor*.
- 4.2 If the *Owner* fails to make payments to the *Contractor* as they become due in accordance with the terms of the *Contract Documents* then interest calculated at 2% per annum over the prime commercial lending rate of the Royal Bank of Canada on such unpaid amounts shall also become due and payable until payment. Such interest shall be calculated and added to any unpaid amounts monthly.

Article 5 Rights and Remedies

- 5.1 The duties and obligations imposed by the Contract Documents and the rights and remedies available thereunder shall be in addition to and not a limitation of any duties, obligations, rights and remedies otherwise imposed or available by law.
- 5.2 Except as specifically set out in the Contract Documents, no action or failure to act by the *Owner*, Contract Administrator or *Contractor* shall constitute a waiver of any of the parties' rights or duties afforded under the *Contract*, nor shall any such action or failure to act constitute an approval of or acquiescence in any breach under the *Contract*.

Article 6 Notices

6.1 Communications among the *Owner*, the *Contract Administrator* and the *Contractor*, including all written notices required by the *Contract Documents*, may be delivered by hand, or by fax, or by pre-paid registered mail, or by email to the addresses as set out below:

The *Owner*:

Regional District of Central Kootenay

202 Lakeside Drive

Nelson BC, V1L 6B9

Fax: (250) 352-9300

Email: chogan@rdck.bc.ca

Attention: Carolyn Hogan, Project Manager

The *Contractor*:

Fax: _____

Email: _____

Attention: _____

The *Contract Administrator*:

Highland Consulting Ltd.

614 Josephine St.

Nelson BC, V1L 1W7

Fax: _____

Email: chusband@highlandconsultingltd.com

Attention: Cooper Husband, P.Eng.

6.2 A communication or notice that is addressed as above shall be considered to have been received

1.1.4 immediately upon delivery, if delivered by hand; or

1.1.5 immediately upon transmission if sent by fax and received in hard copy; or

1.1.6 after 5 *Days* from date of posting if sent by registered mail; or

1.1.7 on the next Business Day following transmission, if sent by email.

6.3 The *Owner* or the *Contractor* may, at any time, change its address for notice by giving written notice to the other at the address then applicable. Similarly if the *Contract Administrator* changes its address for notice then the *Owner* will give or cause to be given written notice to the *Contractor*.

6.4 The sender of a notice by fax assumes all risk that the fax is received in hard copy.

Article 7 General

7.1 This *Contract* shall be construed according to the laws of British Columbia.

7.2 The *Contractor* shall not, without the express written consent of the *Owner*, assign this *Contract*, or any portion of this *Contract*.

7.3 The headings included in the *Contract Documents* are for convenience only and do not form part of this *Contract* and will not be used to interpret, define or limit the scope or intent of this *Contract* or any of the provisions of the *Contract Documents*.

7.4 A word in the *Contract Documents* in the singular includes the plural and, in each case, vice versa.

7.5 This agreement shall ensure to the benefit of and be binding upon the parties and their successors, executors, administrators and assigns.

IN WITNESS WHEREOF the parties hereto have executed this Agreement the day and year first written above.

Contractor:

(FULL LEGAL NAME OF CORPORATION, PARTNERSHIP OR INDIVIDUAL)

(AUTHORIZED SIGNATORY)

(AUTHORIZED SIGNATORY)

Owner:

(FULL LEGAL NAME OF CORPORATION, PARTNERSHIP OR INDIVIDUAL)

(AUTHORIZED SIGNATORY)

(AUTHORIZED SIGNATORY)

(INCLUDE IN LIST ALL DOCUMENTS INCLUDING, IF ANY, SUPPLEMENTARY GENERAL CONDITIONS, SUPPLEMENTARY SPECIFICATIONS, SUPPLEMENTARY STANDARD DETAIL DRAWINGS.)

Schedule 1 Schedule of Contract Documents

The following is an exact and complete list of the Contract Documents, as referred to in Article 2.1 of the Agreement.

NOTE: The documents noted with "*" are contained in the "Master Municipal Construction Documents - General Conditions, Specifications and Standard Detail Drawings", edition dated 2019. All sections of this publication are included in the Contract Documents.

- 8.1 Agreement, including all Schedules;
- 8.2 Supplementary General Conditions (MMCD Volume II, 2019 Edition);
- 8.3 General Conditions*;
- 8.4 Supplementary Specifications (MMCD Volume II, 2019 Edition);
- 8.5 Specifications*;
- 8.6 Standard Detail Drawings*;
- 8.7 Executed Form of Tender, including all Appendices;
- 8.8 Contract Drawings listed in Schedule 2 to the Agreement – "List of Contract Drawings";
- 8.9 Instructions To Tenderers - Part I;
- 8.10 Instructions to Tenderers - Part II*;
- 8.11 The following Addenda:

(ADDENDA, IF ANY)

- 8.13 MMCD Supplementary Updates
 - 2019 Edition Updates – 2021-04-23 (2021-01 to 2021-04)
 - 2019 Edition Updates – 2022-04-07 (2022-01 to 2022-06)
 - EXCLUDING 2022-06
 - 2019 Edition Updates – 2024-05-23 (2024-01 to 2024-07)
 - 2019 Edition Updates – 2025-04-18 (2025-01 to 2025-09)
 - EXCLUDING 2025-05
 - EXCLUDING 2025-08
 - 2019 Edition Updates – 2025-11-13 (2025-10 to 2025-015)

Supplementary General Conditions



HIGHLAND CONSULTING LTD
CIVIL ENGINEERING

MMCD (2019 Edition)
SUPPLEMENTARY GENERAL CONDITIONS

The following Supplementary General Conditions included in this section of the *Contract Documents* are modifications or additions to the General Conditions in the Master Municipal Construction Document Volume II, 2019 Edition.

The following supplemental updates are specific to the tendered project.

Supplemental Update No.	01 - General Conditions – 1.66.1		
Affected Document:	Volume II 2019 Edition	Change Type:	Replace
Section:	GC 1.66 Substantial Performance	Change Summary:	Substantial Performance Definition
Currently:	<p>1.66.1</p> <p>“Substantial Performance” means the stage of completion when:</p> <p>All Work, as certified by the <i>Contract Administrator</i>, is capable of completion or correction at a cost of not more than:</p> <ol style="list-style-type: none"> 1) 3% of the first \$500,000 of the <i>Contract Price</i>; 2) 2% of the next \$500,000 of the <i>Contract Price</i>; and 3) 1% of the balance of the <i>Contract Price</i>; and <p>the <i>Work</i>, or a substantial part of it, is ready for use or is being used for the purpose intended.</p>		
Should Be:	<p>1.66.1</p> <p>“Substantial Performance” means the stage of completion when:</p> <ol style="list-style-type: none"> .1 All Work, as certified by the <i>Contract Administrator</i>, is capable of completion or correction at a cost of not more than: <ol style="list-style-type: none"> 1) 3% of the first \$500,000 of the <i>Contract Price</i>; 2) 2% of the next \$500,000 of the <i>Contract Price</i>; and 3) 1% of the balance of the <i>Contract Price</i>; and .2 the <i>Work</i>, or a substantial part of it, is ready for use or is being used for the purpose intended; and .3 all necessary signoffs from private property owners whose property was affected by construction activities have been obtained and submitted to the <i>Contract Administrator</i>; and .4 the <i>Contractor</i> has submitted required digital as-built survey information, hardcopy redline markups, measurements, test results, video, manuals, and other specified information has been submitted to the <i>Contract Administrator</i>. 		

Supplemental Update No.	02 - General Conditions – 3.3.5		
Affected Document:	Volume II 2019 Edition	Change Type:	Replace
Section:	GC 3.3 <i>Contract Administration</i>	Change Summary:	Survey Control Points
Currently:	<p>3.3.5</p> <p>Unless otherwise specified in the <i>Contract Documents</i>, the <i>Contract Administrator</i> shall set out or cause to be set out survey monuments or control points at the <i>Place of the Work</i>, sufficient to enable the <i>Contractor</i> to determine the required lines and grades, and to set out the <i>Work</i>. The <i>Contractor</i> shall protect and preserve such monuments and control points for so long as they are required for the <i>Work</i> and if any of them must be replaced because they are disturbed or destroyed by the <i>Contractor</i>, then the <i>Contractor</i> shall pay the costs of such replacement.</p>		
Should Be:	<p>3.3.5</p> <p>Unless otherwise specified in the <i>Contract Documents</i>, the <i>Contract Administrator</i> shall provide <i>Drawings</i> that include site specific layout information related to the <i>Place of the Work</i> that is sufficient to enable the <i>Contractor</i> to determine the required lines and grades, and to set out the <i>Work</i>. The provided layout information should include at minimum:</p> <ul style="list-style-type: none"> • Survey layout information of the <i>Work</i> including geometry, alignments, curve data, coordinates and elevations and/or offsets from property lines, as applicable. <p>If the information provided proves to be insufficient to layout the work, then the <i>Contractor</i> shall submit a written request for <i>Additional Instructions</i> under GC 3.3.3.</p> <p>At the <i>Contractor's</i> written request and at <i>Owner's</i> option, the <i>Owner</i> may provide the <i>Contractor</i> with electronic copies of the <i>Contract Drawings</i>, design digital terrain model, or other such information. Information provided shall follow the <i>Owner's</i> terms and conditions for use.</p> <p>Any additional electronic information provided by the <i>Owner</i> is not a substitute for hard copy <i>Contract Documents</i>.</p> <p>Survey layout for all <i>Work</i> shall be the <i>Contractor's</i> responsibility. The <i>Contractor</i> shall protect and preserve monuments and control points for so long as they are required for the <i>Work</i> and if any of them must be replaced because they are disturbed or destroyed by the <i>Contractor</i>, then the <i>Contractor</i> shall pay the costs of such replacement.</p>		

SUPPLEMENTARY GENERAL CONDITIONS

Supplemental Update No.	03 - General Conditions - 4.1.2		
Affected Document:	Volume II 2019 Edition	Change Type:	Replace
Section:	GC 4.1 Control of the <i>Work</i>	Change Summary:	Include Waste Material Removal
Currently:	<p>4.1.2</p> <p>The <i>Contractor</i> shall maintain the <i>Work</i> in a tidy condition and free from the accumulation of waste, debris and waste products, other than that caused by the <i>Owner</i>, <i>Other Contractors</i> or their employees.</p>		
Should Be:	<p>4.1.2</p> <p>The <i>Contractor</i> shall maintain the <i>Work</i> in a tidy condition and free from the accumulation of waste, debris and waste products, other than that caused by the <i>Owner</i>, <i>Other Contractors</i> or their employees.</p> <p>All waste materials, including native materials that are deemed by the <i>Contract Administrator</i> to be unsuitable for re-use, are to be removed from the site and disposed of at dump site(s) obtained by the <i>Contractor</i>.</p>		

Supplemental Update No.	04 - General Conditions - 4.1.3		
Affected Document:	Volume II 2019 Edition	Change Type:	Addition
Section:	GC 4.1 Control of the <i>Work</i>	Change Summary:	Inclusion of Hours of <i>Work</i>
Currently:	N/A		
Should Be:	<p>4.1.3</p> <p>The hours of <i>Work</i> carried out by the <i>Contractor</i> shall comply with the local bylaws applicable to the project location.</p> <p>1) <i>Work</i> can be carried out within the time frame of 07:00 – 19:00 from Monday to Friday. <i>Work</i> shall only be carried out on weekends after receiving written authorization from the <i>Owner</i>. No <i>Work</i> will be carried out on statutory holidays.</p>		

Supplemental Update No.	05 - General Conditions - 4.2.1		
Affected Document:	Volume II 2019 Edition	Change Type:	Addition
Section:	GC 4.2 Safety	Change Summary:	Inclusion of Overhead Power Lines Safety
Currently:	N/A		
Should Be:	<p>4.2.2</p> <p>The <i>Contractor</i> shall complete Worksafe BC form 30M33 prior to working in the vicinity of overhead power lines.</p>		

Supplemental Update No.	06 - General Conditions - 4.3.7		
Affected Document:	Volume II 2019 Edition	Change Type:	Addition
Section:	GC 4.3 Protection of <i>Work</i> , Property and the Public	Change Summary:	Add Pre-Construction Inspection
Currently:	N/A		
Should Be:	<p>4.3.7</p> <p>Before commencing any <i>Work</i> at the <i>Place of Work</i> the <i>Contractor</i> shall:</p> <ol style="list-style-type: none"> 1) conduct a pre-work site inspection and create a photographic or video record of the <i>Place of Work</i>. The inspection should focus on the condition of the roads, adjacent properties, and infrastructure. 2) provide a complete copy of the photographic or video record to the <i>Contract Administrator</i> after the inspection. This record will become the official record of the project's condition before the <i>Work</i> began. The pre-construction inspection should be conducted with the presence of the <i>Contract Administrator</i> or their representative. 		

Supplemental Update No.	07 - General Conditions – 4.3.8		
Affected Document:	Volume II 2019 Edition	Change Type:	Addition
Section:	GC 4.3 Protection of <i>Work</i> , Property and the Public	Change Summary:	Add Responsibility for Existing Surface Features
Currently:	N/A		
Should Be:	<p>4.3.8</p> <p>The <i>Drawings</i> may not depict all surface features that could be encountered during construction, and their location may not be guaranteed. The <i>Contractor</i> assumes sole responsibility for verifying the existence, extent, and location of surface features that may affect the <i>Work</i>, whether they are depicted in the <i>Drawings</i> or not. The protection, restoration, or removal of surface features affected by the <i>Work</i> or for any impact they may have on the <i>Work</i> itself is considered incidental to payment for work described in other Sections unless shown otherwise in the <i>Schedule of Quantities and Prices</i>.</p>		

Supplemental Update No.	08 - General Conditions – 4.9.3		
Affected Document:	Volume II 2019 Edition	Change Type:	Addition
Section:	GC 4.9 Materials	Change Summary:	
Currently:	N/A		
Should Be:	<p>4.9.3</p> <p>The <i>Owner</i> may supply certain materials for incorporation into the <i>Work</i>. The <i>Contractor</i> shall be responsible for receiving, unloading, verifying quantities, storing, handling, protecting, and installing all <i>Owner</i>-supplied materials in accordance with the Contract Documents and the manufacturer’s recommendations.</p> <p>The <i>Contractor</i> shall, upon receipt, inspect all <i>Owner</i>-supplied materials and promptly notify the <i>Contract Administrator</i> in writing of any deficiencies, damage, discrepancies in quantity or type, or materials deemed unsuitable for installation. Materials not reported as deficient or unsuitable at the time of receipt shall be deemed to have been accepted by the <i>Contractor</i> as suitable for use.</p> <p>The <i>Contractor</i> shall be responsible for all loss of or damage to <i>Owner</i>-supplied materials after receipt, including during storage, handling, and installation, and shall, at its own cost, repair or replace such materials to the satisfaction of the <i>Contract Administrator</i>.</p> <p>Only those materials specifically identified in <i>the Schedule of Quantities and Prices</i> as <i>Owner</i>-supplied shall be provided by the <i>Owner</i>. All other materials, including all ancillary items required for a complete and operable installation, shall be supplied by the <i>Contractor</i>.</p> <p>No separate payment will be made for receiving, unloading, inspecting, handling, storing, or protecting <i>Owner</i>-supplied materials, and all such costs shall be deemed incidental to the <i>Work</i>, unless expressly provided otherwise in the Contract Documents.</p>		

Supplemental Update No.	09 - General Conditions – 4.12.11		
Affected Document:	Volume II 2019 Edition	Change Type:	Addition
Section:	GC 4.12 Tests and Inspections	Change Summary:	Testing Requirements
Currently:	N/A		
Should Be:	<p>4.12.11</p> <ol style="list-style-type: none"> 1) All <i>Quality Control</i> testing and inspections by the <i>Contractor</i> must meet the bylaw requirements of the <i>Owner</i> or requirements of the appropriate regulatory agency in terms of test type, frequency, and number of tests required. 2) Materials testing must be conducted by an accredited materials testing company that typically performs such work, and overseen by a P.Eng. registered in BC who is an employee of the materials testing company. 3) The frequency, number, and type of tests concerning the restoration of roads must adhere to MoTT standards for road gravels and asphalt. 4) The <i>Contractor</i> must submit all test results to the <i>Contract Administrator</i>. 		

Supplemental Update No.	10 - General Conditions – 4.12.12		
Affected Document:	Volume II 2019 Edition	Change Type:	Addition
Section:	GC 4.12 Tests and Inspections	Change Summary:	Add Owner's Rights to Independent Testing
Currently:	N/A		
Should Be:	<p>4.12.12</p> <p>The <i>Owner</i> reserves the right to employ and pay for an independent testing firm to conduct quality assurance tests to determine compliance with the <i>Contract Documents</i>, at the <i>Owner's</i> cost.</p> <p>The number and frequency of tests shall be at the discretion of the <i>Owner</i>.</p>		

Supplemental Update No.	11 - General Conditions - 13.9.1		
Affected Document:	Volume II 2019 Edition	Change Type:	Replace
Section:	GC 13.9 Liquidated Damages for Late Completion	Change Summary:	Late Completion Value Change
Currently:	<p>13.9.1</p> <p>If the <i>Contractor</i> fails to meet the <i>Milestone Date for Substantial Performance</i> as set out in the <i>Form of Tender</i>, paragraph 2.2 as may be adjusted pursuant to the provisions of the <i>Contract Documents</i>, then the <i>Owner</i> may deduct from any monies owing to the <i>Contractor</i> for the <i>Work</i>:</p> <ol style="list-style-type: none"> 1) as a genuine pre-estimate of the <i>Owner's</i> increased costs for the <i>Contract Administrator</i> and the <i>Owner's</i> own staff caused by such a delay an amount of \$1000.00 per day or pro rata portion for each Day that actual <i>Substantial Performance</i> is achieved after the <i>Substantial Performance Milestone Date</i>; plus 2) all direct out-of-pocket costs, such as costs for safety, security, or equipment rental, reasonably incurred by the <i>Owner</i> as a direct result of such delay. <p>If the monies owing to the <i>Contractor</i> are less than the total amount owing by the <i>Contractor</i> to the <i>Owner</i> under 13.9.1(1) and (2) than any shortfall shall immediately, upon written notice from the <i>Owner</i>, and upon <i>Substantial Performance</i>, be due and owing by the <i>Contractor</i> to the <i>Owner</i>.</p>		
Should Be:	<p>13.9.1</p> <p>If the <i>Contractor</i> fails to meet the <i>Milestone Date for Substantial Performance</i> as set out in the <i>Form of Tender</i>, paragraph 2.2 as may be adjusted pursuant to the provisions of the <i>Contract Documents</i>, then the <i>Owner</i> may deduct from any monies owing to the <i>Contractor</i> for the <i>Work</i>:</p> <ol style="list-style-type: none"> 1) as a genuine pre-estimate of the <i>Owner's</i> increased costs for the <i>Contract Administrator</i> and the <i>Owner's</i> own staff caused by such delay an amount of \$500.00 per day or pro rata portion for each Day the actual <i>Substantial Performance</i> is achieved after the <i>Substantial Performance Milestone Date</i>; plus 2) all direct out-of-pocket costs, such as costs for safety, security, or equipment rental, reasonably incurred by the <i>Owner</i> as a direct result of such delay. <p>If the monies owing to the <i>Contractor</i> are less than the total amount owing by the <i>Contractor</i> to the <i>Owner</i> under 13.9.1(1) and (2) than any shortfall shall immediately, upon written notice from the <i>Owner</i>, and upon <i>Substantial Performance</i>, be due and owing by the <i>Contractor</i> to the <i>Owner</i>.</p>		

Supplemental Update No.	11 - General Conditions - 24.1.1																						
Affected Document:	Volume II 2019 Edition	Change Type:	Replace																				
Section:	GC 24.1 Required Insurance	Change Summary:	Remove GC 24.1 INSURANCE and replace entirely																				
Currently:	24.1.1 "Contractor will at the Contractor's expense, carry with an insurance company or companies and under policies of insurance acceptable to and approved by Owner the following insurance limits not less than shown in the respective items:"																						
Should Be:	<p>24.1 REQUIRED INSURANCE - Without restricting the generality of the indemnification provisions of this Agreement, insurance and coverage will be arranged and paid for as under-noted:</p> <p>24.1.1 The Contractor must take out and maintain the insurance coverages detailed in this section 24.1 and shall provide the Owner evidence of coverage upon execution of this Agreement in the following format:</p> <ul style="list-style-type: none"> • an ICBC form APV 47; and • the Owner's Standard Certificate of Insurance form completed by the Contractor's broker. <table border="1" data-bbox="500 982 1495 1860"> <thead> <tr> <th data-bbox="500 982 740 1087">COVERAGE TYPE</th> <th data-bbox="740 982 1133 1087">MINIMUM AMOUNT</th> <th data-bbox="1133 982 1312 1087">MINIMUM AGGREGATE</th> <th data-bbox="1312 982 1495 1087">DEDUCTIBLE MAXIMUM</th> </tr> </thead> <tbody> <tr> <td data-bbox="500 1087 740 1335">Automobile Liability (third party) Insurance for vehicles used to complete the Services.</td> <td data-bbox="740 1087 1133 1335" style="text-align: center;">\$5,000,000 per occurrence</td> <td data-bbox="1133 1087 1312 1335" style="text-align: center;">N/A</td> <td data-bbox="1312 1087 1495 1335" style="text-align: center;">N/A</td> </tr> <tr> <td data-bbox="500 1335 740 1440">Commercial General Liability</td> <td data-bbox="740 1335 1133 1440" style="text-align: center;">\$5,000,000 per occurrence</td> <td data-bbox="1133 1335 1312 1440" style="text-align: center;">N/A</td> <td data-bbox="1312 1335 1495 1440" style="text-align: center;">\$5,000</td> </tr> <tr> <td data-bbox="500 1440 740 1612">Pollution/ Environmental Impairment Liability</td> <td data-bbox="740 1440 1133 1612" style="text-align: center;">\$2,000,000 per claim</td> <td data-bbox="1133 1440 1312 1612" style="text-align: center;">N/A</td> <td data-bbox="1312 1440 1495 1612" style="text-align: center;">\$5,000</td> </tr> <tr> <td data-bbox="500 1612 740 1860">All Risk Property</td> <td data-bbox="740 1612 1133 1860" style="text-align: center;">Equivalent to the replacement cost of all owned, rented and/or leased equipment of the Contractor and materials purchased by the Contractor for the Services.</td> <td data-bbox="1133 1612 1312 1860" style="text-align: center;">N/A</td> <td data-bbox="1312 1612 1495 1860" style="text-align: center;">N/A</td> </tr> </tbody> </table>			COVERAGE TYPE	MINIMUM AMOUNT	MINIMUM AGGREGATE	DEDUCTIBLE MAXIMUM	Automobile Liability (third party) Insurance for vehicles used to complete the Services.	\$5,000,000 per occurrence	N/A	N/A	Commercial General Liability	\$5,000,000 per occurrence	N/A	\$5,000	Pollution/ Environmental Impairment Liability	\$2,000,000 per claim	N/A	\$5,000	All Risk Property	Equivalent to the replacement cost of all owned, rented and/or leased equipment of the Contractor and materials purchased by the Contractor for the Services.	N/A	N/A
COVERAGE TYPE	MINIMUM AMOUNT	MINIMUM AGGREGATE	DEDUCTIBLE MAXIMUM																				
Automobile Liability (third party) Insurance for vehicles used to complete the Services.	\$5,000,000 per occurrence	N/A	N/A																				
Commercial General Liability	\$5,000,000 per occurrence	N/A	\$5,000																				
Pollution/ Environmental Impairment Liability	\$2,000,000 per claim	N/A	\$5,000																				
All Risk Property	Equivalent to the replacement cost of all owned, rented and/or leased equipment of the Contractor and materials purchased by the Contractor for the Services.	N/A	N/A																				

24.1.2 The Contractor shall maintain **Commercial General Liability** coverage for the Term of this Agreement and a minimum of one (1) year after the completion of the Services with Products and Completed Operations coverage extended for an additional year (2 years in total). To achieve the desired limit, umbrella or excess liability insurance may be used. Such insurance will include but is not limited to the following:

- (1) **Broad Form bodily injury, death, property damage, and personal injury** coverage, on an occurrence basis;
- (2) **Non-Owned Automobile** Liability with a limit not less than **\$2,000,000 per occurrence** (including contractual non-owned automobile liability endorsement SEF 96);
- (3) **Blanket Contractual** Liability;
- (4) **Cross Liability** and/or **Severability of Interests**;
- (5) A **Waiver of Subrogation** in favour of the Regional District of Central Kootenay;
- (6) Name "**Regional District of Central Kootenay, its elected officials, officers, employees, servants, and agents**", as an **Additional Insureds**;
- (7) Name "**Highland Consulting Ltd**", as an **Additional Insureds**;
- (8) Name "**His Majesty the King in Right of the Province of British Columbia and Ministry of Transportation and Transit**" as **Additional Insured**;
- (9) Require the insurer to provide the Owner with **30 days written notice** of any material change or cancellation;
- (10) **Premises** and **Operations**;
- (11) **Products** and **Completed Operations**;
- (12) **Attached Machinery**;
- (13) Coverage that is **Primary and Non-Contributory** to any other sources of insurance available to the Contractor or the Owner.

24.1.3 The Contractor shall maintain **Pollution/Environmental Impairment Liability** coverage. This insurance shall be maintained continuously from commencement of the until such *Services are* completed and including a twenty-four (24) month extended reporting period if any such insurance is provided on a claims-made basis. Such insurance shall not be impaired by any biological contaminants (without limitation, mold and bacteria), asbestos, or lead exclusions. Any 'insured vs. insured' exclusion shall not prejudice coverage for the Owner and shall not affect the Owner's ability to bring suit against the Contractor as a third party. Such insurance will include but is not limited to the following:

- (1) **Broad Form bodily injury, death, property damage** coverage, on an occurrence basis;
- (2) **Clean-up, Monitoring and Remediation;**
- (3) **Sudden and Accidental, and Gradual Pollution Events for Third Party Liability;**
- (4) **Asbestos Abatement;**
- (5) **Ongoing and Completed Operations;**
- (6) **Blanket Contractual** Liability endorsement;
- (7) **Cross Liability and/or Severability of Interests;**
- (8) A **Waiver of Subrogation** in favour of the Regional District of Central Kootenay;
- (9) Name **“the Regional District of Central Kootenay, its elected officials, officers, employees, servants, and agents”**, as an **Additional Insured;**
- (10) Name **“Highland Consulting Ltd.”**, as an **Additional Insured;**
- (11) Name **“His Majesty the King in Right of the Province of British Columbia and Ministry of Transportation and Transit**, as **Additional Insured;**
- (12) Require the insurer to provide the Owner with **30 days written notice** of any material change or cancellation;
- (13) must be **Primary and Non-Contributory** to any other sources of insurance available to the *Contractor* or the Owner

24.1.4 The Contractor shall maintain **All Risk Property** coverage for the Term of this Agreement, which shall cover, on a replacement cost basis, all property, of every description, to be used in the Services, against “All Risks” of physical loss or damage, including earthquake and flood, while such property is being transported to the Site, and thereafter throughout erection, installation and testing. Such insurance will include but is not limited to the following:

- (1) **Installation Floater;**
- (2) A **Waiver of Subrogation** in favour of the Regional District of Central Kootenay.

ADDITIONAL INSURANCE TERMS AND CONDITIONS

24.1.5 Subject to satisfactory proof of financial capability by the Contractor, the Owner may agree to increase the deductible amounts.

24.1.6 The Contractor is solely responsible for determining what additional insurance coverage, if any, is necessary or advisable for the protection of

	<p>the Contractor or that is required by the Contractor to fulfill its obligations under this Agreement, with such additional insurance maintained and provided at the sole expense of the Contractor and with the Contractor being responsible for obtaining whatever additional insurance it deems necessary.</p> <p>24.1.7 The Contractor shall pay the deductible amounts in the event of a claim which the above policies are required to pay.</p> <p>24.1.8 The Contractor shall ensure that all insurance required to be maintained by the Contractor under this Agreement is underwritten by a responsible insurance company or companies licensed to do business in the province of British Columbia.</p> <p>24.1.9 As may be applicable, the Contractor must cause all subcontractors to comply with the insurance requirements outlined in section 24.1 of this Agreement.</p> <p>24.1.10 The Owner may, at its discretion, notify the Contractor that the terms, amounts and types of insurance required to be obtained by the Contractor hereunder be changed. The Contractor shall, upon request, obtain a written quote from its insurer for the incremental cost of such additional or amended coverage and submit that quote to the Owner for review. The Owner may, in its sole discretion, approve or decline the proposed increase. Where the Owner approves the increase in writing, the Owner will pay the approved incremental cost increase, and the parties shall record the change and payment terms in an Agreement Amendment. The Contractor shall not bind or purchase the increased or amended coverage until Owner's written approval is provided.</p> <p>24.1.11 If the Contractor's insurance policies expire prior to the coverage periods identified in section 21.1 of this Agreement, the Contractor shall renew its insurance policies prior to the expiry date and provide the Owner with an updated evidence of insurance in the format identified in section 24.1.1, confirming such renewal to the Owner within 14 days of its current policy's expiry.</p> <p>24.1.12 In the event the Contractor shall fail to take out and maintain such insurance at all times during the coverage periods identified in section 24.1 the Owner shall be entitled to take out and maintain equivalent insurance at the cost of the Contractor and the Contractor will pay to the Owner, on demand, the Owner's cost of so doing, or at the option of the Owner, the Owner shall be entitled to terminate this Agreement.</p>
--	--

Supplementary Specifications



HIGHLAND CONSULTING LTD
CIVIL ENGINEERING

MMCD (2019 Edition)
SUPPLEMENTARY SPECIFICATIONS

SUPPLEMENTARY SPECIFICATIONS

The following Supplementary Specifications included in this section of the *Contract Documents* are modifications or additions to the Specifications in the Master Municipal Construction Document Volume II 2019 Edition.

Supplemental Update No.	01 - Specifications – 01 33 01 - 1.7.2		
Affected Document:	Volume II 2019 Edition	Change Type:	Replacement
Section:	Specifications 01 33 01 Project Record Documents	Change Summary:	Add project record requirements
Currently:	<p>1.7.2</p> <p>Contract Drawings and shop drawings: legibly mark each item to record actual construction, including:</p> <ol style="list-style-type: none"> 1) Measured horizontal and vertical locations of underground utilities and appurtenances, referenced to permanent surface improvements. 1) Field changes of dimensions and detail. 2) Changes made by Addenda and Change Orders 3) Details not on original Contract Drawings 2) References to related shop drawings and modifications 		
Should Be:	<p>1.7.2</p> <p>Contract Drawings and shop drawings: legibly mark each item to record actual construction, including:</p> <ol style="list-style-type: none"> 1) Measured horizontal and vertical locations of existing and installed underground utilities and appurtenances, referenced to permanent surface improvements. Records shall be accurate to within 75mm horizontally and 15mm vertically. 2) All surface changes or improvements. 3) Field changes of dimensions and detail. 4) Changes made by Addenda and Change Orders 5) Details not on original Contract Drawings 6) References to related shop drawings and modifications <p>Redlined drawings shall be maintained in a digital format that is easily transferable into AutoCAD and submitted to the Contract Administrator no later than Substantial Performance.</p>		

SUPPLEMENTARY SPECIFICATIONS

Supplemental Update No.	02 - Specifications – 01 33 01 - 1.7.5		
Affected Document:	Volume II 2019 Edition	Change Type:	Addition
Section:	Specifications 01 33 01 Project Record Documents	Change Summary:	Add project record requirements
Currently:	N/A		
Should Be:	<p>1.7.5</p> <p>The Owner may provide a surveyor to record the location of installed works. If required by the Contract Administrator, the Contractor shall:</p> <ol style="list-style-type: none"> 1) Meet the surveyor at the Place of Work and clearly identify to the surveyor the location of all installed works, including buried utilities, structures, and appurtenances. 2) Cooperate fully with the surveyor to ensure that accurate and complete record information is obtained. 		

Supplemental Update No.	03 - Specifications – 01 33 01 - 1.7.6		
Affected Document:	Volume II 2019 Edition	Change Type:	Addition
Section:	01 33 01 – Project Record Documents	Change Summary:	Add daily site record requirements
Currently:	N/A		
Should Be:	<p>1.7.6</p> <p>The Contractor is responsible for maintaining daily site records, which must be submitted to the Owner and Contract Administrator daily. These records must include the following minimum information:</p> <ul style="list-style-type: none"> • Site conditions • Weather conditions • High-quality digital photographs of each stage of construction, showing evidence of the <i>Work</i> completed • Any questions directed to the Owner, Engineer, or Contract Administrator • <i>Work</i> that has been completed • Make, model, and manufacturer specifications of all materials installed each day, including reference to previous day's work if materials have not changed • Soil gradations and proctors for each backfill and road gravel material used, as provided by a qualified testing laboratory • Other relevant information 		

SUPPLEMENTARY SPECIFICATIONS

Supplemental Update No.	04 - Specifications – 01 51 01 – 1.5.2		
Affected Document:	Volume II 2019 Edition	Change Type:	Addition
Section:	01 51 01 – Temporary Utilities And Lighting	Change Summary:	Retention of Temporary Water Materials
Currently:	N/A		
Should Be:	<p>1.5.2</p> <p>Temporary water supply shall be provided as indicated in the Contract Drawings.</p> <p>All materials used for the temporary water connection, including piping, fittings, and valves, shall be retained by the Owner following removal of temporary water supply unless otherwise specified.</p>		

Supplemental Update No.	05 - Specifications – 01 52 01 - 1.3.1		
Affected Document:	Volume II 2019 Edition	Change Type:	Replace
Section:	01 52 01 Temporary Structures	Change Summary:	Remove Office Requirements
Currently:	<p>1.3.1</p> <p>Provide and maintain in clean condition during progress of work, adequately lighted, heated, and ventilated facilities for:</p> <ol style="list-style-type: none"> 1) Contract Administrator’s temporary office 2) Contractor’s office with space for filing and layout of Contract Documents and Contractor’s normal site office staff. 		
Should Be:	<p>1.3.1</p> <p>Provide and maintain in clean condition during progress of work, adequately lighted, heated, and ventilated facilities for:</p> <ol style="list-style-type: none"> 1) Contractor’s office, as necessary, with space for filing and layout of Contract Documents and Contractor’s normal site office staff. 		

SUPPLEMENTARY SPECIFICATIONS

Supplemental Update No.	06 - Specifications – 01 52 01 - 1.6.1		
Affected Document:	Volume II 2019 Edition	Change Type:	Replace
Section:	01 52 01 Temporary Structures	Change Summary:	Change Office Payment
Currently:	<p>1.6.1</p> <p>Payment for Site Office as a separate pay item includes all the requirements under 1.3. of this Section. Progress payment for Site Office included as a separate lump Sum item will be</p> <ol style="list-style-type: none"> 1) 40% upon fully providing the facilities required; 2) 50% in equal monthly payments to cover the maintenance of the facilities provided and 3) The remaining 10% upon removal of the facilities upon completion of the Contract. 		
Should Be:	<p>1.6.1</p> <p>Payment for all work performed under this Section will be incidental to payment for work described in other Sections unless shown otherwise in the Schedule of Quantities and Prices.</p>		

Supplemental Update No.	07 - Specifications – 01 53 01 – 1.9.2		
Affected Document:	Volume II 2019 Edition	Change Type:	Addition
Section:	01 53 01 – Temporary Facilities	Change Summary:	Mobilization/Demobilization
Currently:	N/A		
Should Be:	<p>1.9.2</p> <p>Payment for mobilization and demobilization shall include all work, materials, equipment, and labour required to mobilize and demobilize all personnel, equipment, and materials to and from the Place of Work.</p> <p>Payment shall be made at 50% of the lump sum value included in the Schedule of Quantities for mobilization and 50% for demobilization.</p>		

Supplemental Update No.	08 - Specifications – 01 55 00 - 1.06		
Affected Document:	Volume II 2019 Edition	Change Type:	Addition
Section:	01 55 00 Traffic Control, Vehicle Access and Parking	Change Summary:	Traffic Control Plan
Currently:	<p>1.06</p> <p>Prepare a Traffic Management Plan which utilizes the BCMOTI Template for Traffic Management Plans (June 2017)</p>		
Should Be:	<p>1.06</p> <p>Prepare a Traffic Management Plan (TMP) which utilizes the BCMOTI Template for Traffic Management Plans (2020).</p> <p>The Contractor shall submit the TMP to MoTT for approval at least fifteen (15) working days before the start of construction. MoTT is to issue a "Permit to Construct, Use, and Maintain Works within the Right-of-Way of a Provincial Public Highway", and the Contractor shall follow the requirements of the permit. The Contractor shall be the Prime Contractor for the purposes of the permit.</p> <p>The Contractor shall submit the TMP to the Owner and the Contract Administrator for approval prior to construction.</p>		

Supplemental Update No.	09 - Specifications – 01 58 01 - 1.2.1		
Affected Document:	Volume II 2019 Edition	Change Type:	Replace
Section:	01 58 01 Project Identification	Change Summary:	Remove Project Sign Requirement
Currently:	<p>1.2.1</p> <p>Construction Signage</p> <ol style="list-style-type: none"> 1) Provide and erect, within 3 weeks of signing Contract, a project sign in a location designated by Contract Administrator. 2) Construction sign 1.2 m x 2.4 m, of wood frame and plywood construction painted with exhibit lettering produced by a professional sign painter. 3) Indicate on sign, name of Owner, Contract Administrator and Contractor, of a design style approved by Contract Administrator. 4) Maintain sign in good condition for the duration of work. Clean periodically. 5) No other signs or advertisements, other than warning signs, are permitted on site. 		
Should Be:	<p>1.2.1</p> <p>Construction Signage</p> <ol style="list-style-type: none"> 1) No signs or advertisements, other than project identification signs and warning signs, are permitted on site. 		

SUPPLEMENTARY SPECIFICATIONS

Supplemental Update No.	10 - Specifications – 33 11 01 – 1.7.3		
Affected Document:	Volume II 2019 Edition	Change Type:	Replacement
Section:	33 11 01 – Waterworks	Change Summary:	Notification Timing Change
Currently:	<p>1.7.3</p> <p>Notify Contract Administrator, affected residences and businesses minimum of 24 h in advance of any interruption in service.</p>		
Should Be:	<p>1.7.3</p> <p>Notify Contract Administrator, affected residences and businesses minimum of 48 h in advance of any interruption in service.</p> <p>Notify Owner minimum of 7 days in advance of any interruption in service.</p> <p>Notification to affected residences and businesses shall, at a minimum, include:</p> <ul style="list-style-type: none"> • Verbal notification by direct contact at the premises; and • Written notice including the Contractor’s name and contact information, and a 24-hour emergency contact name and phone number. 		

Supplemental Update No.	11 - Specifications – 33 11 01 – 1.8.16		
Affected Document:	Volume II 2019 Edition	Change Type:	Addition
Section:	33 11 01 – Waterworks	Change Summary:	Payment for Restraints
Currently:	N/A		
Should Be:	<p>1.8.16</p> <p>Payment for joint restraints shall be included in the Contract unit price for the appurtenance being restrained, including but not limited to fittings, valves, tees, bends, reducers, and caps.</p> <p>Payment shall include supply, installation, and all labour, materials, and equipment necessary to fully restrain the joint(s) in accordance with the Contract Drawings, Specifications, and manufacturer’s requirements.</p>		

Supplemental Update No.	12 - Specifications – 33 11 01 – 1.8.17		
Affected Document:	Volume II 2019 Edition	Change Type:	Addition
Section:	33 11 01 – Waterworks	Change Summary:	Payment for Tracer wire
Currently:	N/A		
Should Be:	<p>1.8.17</p> <p>Payment for tracer wire shall be included in the Contract unit price for the watermain with which it is installed, and shall include supply, installation, connections, testing, markers, U-channels, and all labour, materials, and equipment necessary to complete the work.</p>		

Supplemental Update No.	13 - Specifications – 33 11 01 – 1.8.18		
Affected Document:	Volume II 2019 Edition	Change Type:	Addition
Section:	33 11 01 – Waterworks	Change Summary:	Payment for Pole Holds
Currently:	N/A		
Should Be:	<p>1.8.18</p> <p>Payment for temporary utility pole holding required for waterworks construction shall be incidental to payment for the Work described in this Section, unless a separate item is included in the Schedule of Quantities and Prices.</p> <p>No additional payment will be made for delays, standby time, or coordination associated with this Work.</p>		

Supplemental Update No.	14 - Specifications – 33 11 01 – 3.1.2		
Affected Document:	Volume II 2019 Edition	Change Type:	Addition
Section:	33 11 01 – Waterworks	Change Summary:	Execution of Pole Holds
Currently:	N/A		
Should Be:	<p>3.1.2</p> <p>Utility poles exist along the proposed watermain alignment within the Place of Work. The need for pole holding will be determined by the final watermain alignment relative to the existing poles and shall be confirmed on site by the Contract Administrator in consultation with the Owner, the Contractor, and the applicable utility company. Where pole holding is required, the Contractor shall be responsible for coordinating with the applicable utility company to arrange and pay for pole holding services, or to provide pole holding as directed by the utility company. The Contractor shall provide all necessary notice, scheduling, and site access to facilitate the work, and if required, shall not excavate in the vicinity of poles until pole holding arrangements are in place.</p>		

SUPPLEMENTARY SPECIFICATIONS

Supplemental Update No.	15 - Specifications – 33 11 01 – 3.17.2		
Affected Document:	Volume II 2019 Edition	Change Type:	Replace
Section:	33 11 01 – Waterworks	Change Summary:	Testing
Currently:	<p>3.17.2</p> <p>Perform all tests in presence of Contract Administrator. Notify Contract Administrator 24 h in advance of proposed test.</p>		
Should Be:	<p>3.17.2</p> <p>Perform all tests in presence of Contract Administrator. Notify Contract Administrator 24 h in advance of proposed test.</p> <p>In the event that the test witnessed by the Contract Administrator does not pass, the Contract Administrator’s time for travel and testing will be billed back to the Contractor and deducted from the progress payment.</p>		

Supplemental Update No.	16 - Specifications – 33 11 01 – 3.21.8.1		
Affected Document:	Volume II 2019 Edition	Change Type:	Addition
Section:	33 11 01 – Waterworks	Change Summary:	Dechlorination Requirements
Currently:	N/A		
Should Be:	<p>3.21.8.1</p> <p>Chlorinated water used for disinfection shall be dechlorinated to a maximum 0.1mg/l chlorine concentration prior to discharge. Dechlorinated water shall be discharged to a location approved by the Contract Administrator.</p>		

SUPPLEMENTARY SPECIFICATIONS

Supplemental Update No.	17 - Specifications – 33 11 01 – 3.21.10		
Affected Document:	Volume II 2019 Edition	Change Type:	Addition
Section:	33 11 01 – Waterworks	Change Summary:	Disinfection Sampling
Currently:	N/A		
Should Be:	<p>3.21.10</p> <p>Upon completion of disinfection and flushing, the Contractor shall collect two consecutive sets of bacteriological samples from each sampling location, taken at least 16 hours apart. Sampling locations shall be at a maximum spacing of 370 m along the watermain, with one sampling location at each end of the watermain.</p> <p>The Contractor shall submit all bacteriological test results to the Contract Administrator.</p> <p>Sampling procedures shall be in accordance with AWWA C651.</p> <p>Analytical testing shall be carried out by an accredited laboratory acceptable to the Contract Administrator.</p> <p>All costs associated with bacteriological sampling and testing shall be considered incidental to the Contract.</p>		

Supplemental Update No.	18 - Specifications – 33 11 01 – 3.23.2		
Affected Document:	Volume II 2019 Edition	Change Type:	Addition
Section:	33 11 01 – Waterworks	Change Summary:	Tie-ins
Currently:	N/A		
Should Be:	<p>3.23.2</p> <p>The Contractor shall not complete the watermain tie-ins until successful completion of the system disinfection and testing and until authorized to do so by the Contract Administrator. All piping, fittings and valves used to complete the tie-ins must be swabbed with a high concentration chlorine solution at the time of the connections.</p>		

END OF SUPPLEMENTARY SPECIFICATIONS

Appendix A: Contract Drawings



HIGHLAND CONSULTING LTD
CIVIL ENGINEERING

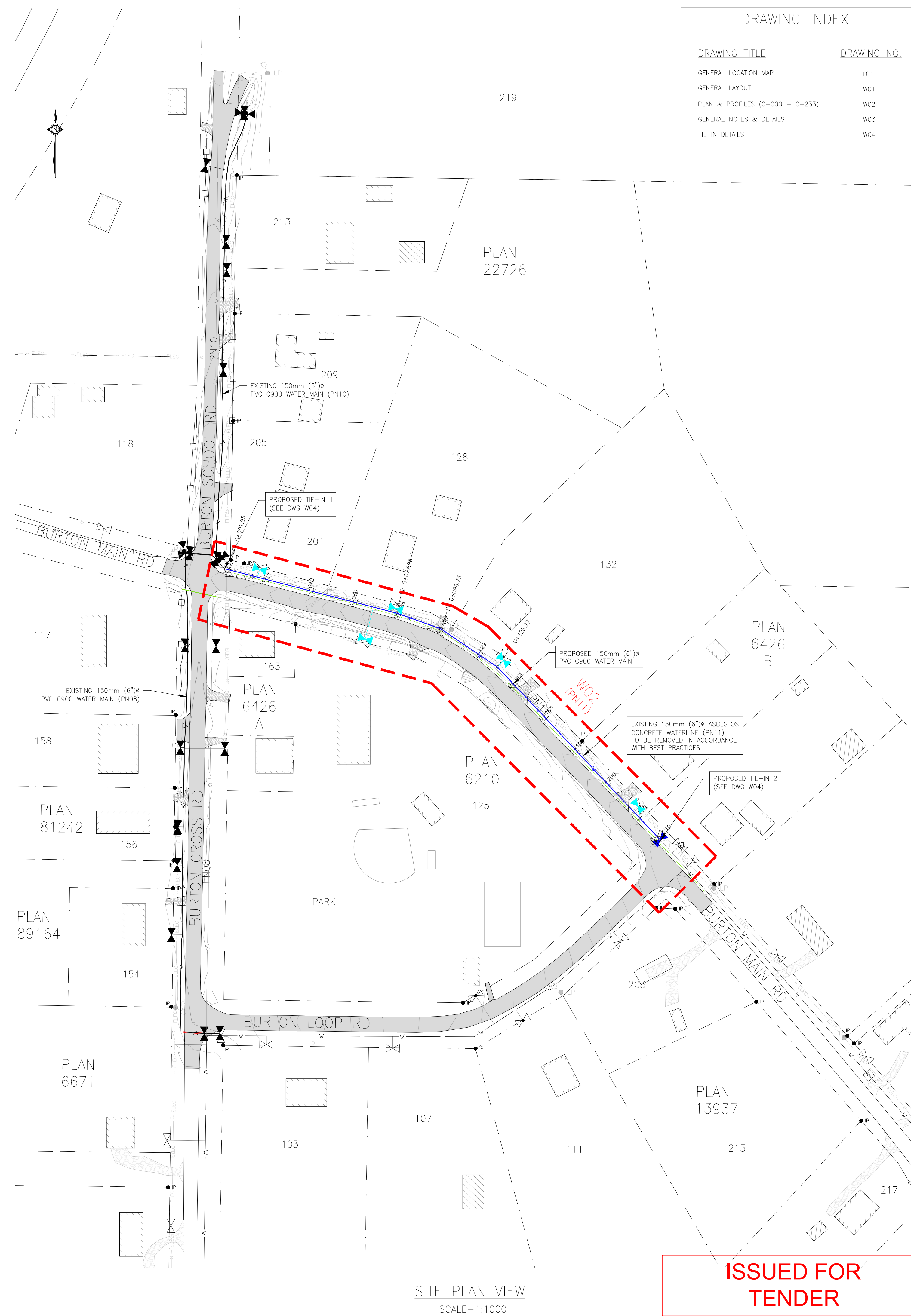

DRAWING INDEX

DRAWING TITLE	DRAWING NO.
GENERAL LOCATION MAP	L01
GENERAL LAYOUT	W01
PLAN & PROFILES (0+000 - 0+233)	W02
GENERAL NOTES & DETAILS	W03
TIE IN DETAILS	W04

LEGEND:

- EXISTING WATER VALVE
- EXISTING HYDRANT
- EXISTING BLOW OFF
- EXISTING AIR RELEASE VALVE
- EXISTING SAMPLE STATION
- EXISTING WATERMAIN (REMOVED)
- EXISTING WATER SERVICE
- EXISTING GAS MAIN
- WATERMAIN
- SERVICE CONNECTION
- WATER VALVE
- CURB STOP
- HYDRANT
- BLOW OFF
- SAMPLE STATION
- AIR RELEASE VALVE
- END CAP
- CARRIER PIPE

GENERAL NOTES:

ALL DIMENSIONS ARE SPECIFIED IN METERS UNLESS OTHERWISE STATED.

LOT PLAN BASED ON ROCK MAPPING DATA AND SURVEY CARRIED OUT BY CLIENT. HIGHLAND CONSULTING IS NOT LIABLE FOR INACCURACIES IN DRAWING.

SCALE IS BASED ON ARCH EXPANDED D (24"x36") DRAWINGS.

NO VARIATION TO THIS DRAWING SHALL BE PERMITTED UNLESS AUTHORIZED BY ENGINEER IN WRITING.

AERIAL IMAGERY FROM ROCK MAPPING IMPORTED OCTOBER 22, 2024

REFER TO W03 FOR ADDITIONAL NOTES

REV.	DESCRIPTION	DATE
E	ISSUED FOR TENDER	26-MAR-26
D	ISSUED FOR PERMIT	19-MAR-26
C	ISSUED FOR PERMIT	23-FEB-26
B	90% DD FOR REVIEW	09-FEB-26
A	50% DD FOR REVIEW	23-DEC-25

HIGHLAND CONSULTING LTD
 CIVIL ENGINEERING
 614 Josephine St.
 Nelson, BC
 V1L 1W7
 Canada
 C 250 551 1416
 pkernan@highlandconsultingtd.com

This drawing not to be used for construction purposes until noted and dated "Issued for Construction". All measurements must be checked on site and be verified with the drawings by Contractor.

Copyright reserved. This drawing and design is and at all times remains the exclusive property of Highland Consulting and cannot be used without their written consent. The information contained herein is for use of the client only. Highland Consulting is not liable to any other parties relating to the use of this drawing.

PROJECT TITLE
BURTON WATER SYSTEM UPGRADE PN11

DRAWING TITLE
GENERAL LOCATION MAP

CLIENT NAME
RDCK

SCALE: REFER TO DWG	JOB No. 24735
DRAWN: JH	REVISION
CHECKED: PK	DWG. No.
DATE: 26-Mar-26	L01
PLOT: 26-Mar-26	

ISSUED FOR TENDER



- LEGEND:**
- EXISTING WATER VALVE
 - EXISTING HYDRANT
 - EXISTING BLOW OFF
 - EXISTING SAMPLE STATION
 - EXISTING AIR RELEASE VALVE
 - EXISTING WATERMAIN (REMOVED)
 - EXISTING WATER SERVICE
 - EXISTING GAS MAIN
 - WATERMAIN
 - SERVICE CONNECTION
 - WATER VALVE
 - CURB STOP
 - HYDRANT
 - BLOW OFF
 - SAMPLE STATION
 - AIR RELEASE VALVE
 - END CAP
 - CARRIER PIPE

GENERAL NOTES:

ALL DIMENSIONS ARE SPECIFIED IN METERS UNLESS OTHERWISE STATED.

LOT PLAN BASED ON ROCK MAPPING DATA AND SURVEY CARRIED OUT BY CLIENT. HIGHLAND CONSULTING IS NOT LIABLE FOR INACCURACIES IN DRAWING.

SCALE IS BASED ON ARCH EXPANDED D (24"x36") DRAWINGS.

NO VARIATION TO THIS DRAWING SHALL BE PERMITTED UNLESS AUTHORIZED BY ENGINEER IN WRITING.

AERIAL IMAGERY FROM ROCK MAPPING IMPORTED OCTOBER 22, 2024

REFER TO W03 FOR ADDITIONAL NOTES

REV.	DESCRIPTION	DATE
E	ISSUED FOR TENDER	26-MAR-26
D	ISSUED FOR PERMIT	19-MAR-26
C	ISSUED FOR PERMIT	23-FEB-26
B	90% DD FOR REVIEW	09-FEB-26
A	50% DD FOR REVIEW	23-DEC-25

HIGHLAND CONSULTING LTD
 CIVIL ENGINEERING
 614 Josephine St.
 Nelson, BC
 V1L 1W7
 Canada
 C 250 551 1416
 pkernan@highlandconsultingltd.com

This drawing not to be used for construction purposes until noted and dated "Issued for Construction". All measurements must be checked on site and be verified with the drawings by Contractor.

Copyright reserved. This drawing and design is and at all times remains the exclusive property of Highland Consulting and cannot be used without their written consent. The information contained herein is for use of the client only. Highland Consulting is not liable to any other parties relating to the use of this drawing.

SEAL

PROJECT TITLE
BURTON WATER SYSTEM UPGRADE PN11

DRAWING TITLE
GENERAL LAYOUT

CLIENT NAME
RDCK

SCALE: REFER TO DWG	JOB No. 24735
DRAWN: JH	REVISION
CHECKED: PK	DWG. No.
DATE: 26-Mar-26	W01
PLOT: 26-Mar-26	

ISSUED FOR TENDER

C:\Users\jpkernan\OneDrive\My Documents\PROJECTS\2025\24735\RDCK\Burton Water System Upgrade\Drawings\W01_General Layout.dwg
 FILE: W01_General Layout.dwg

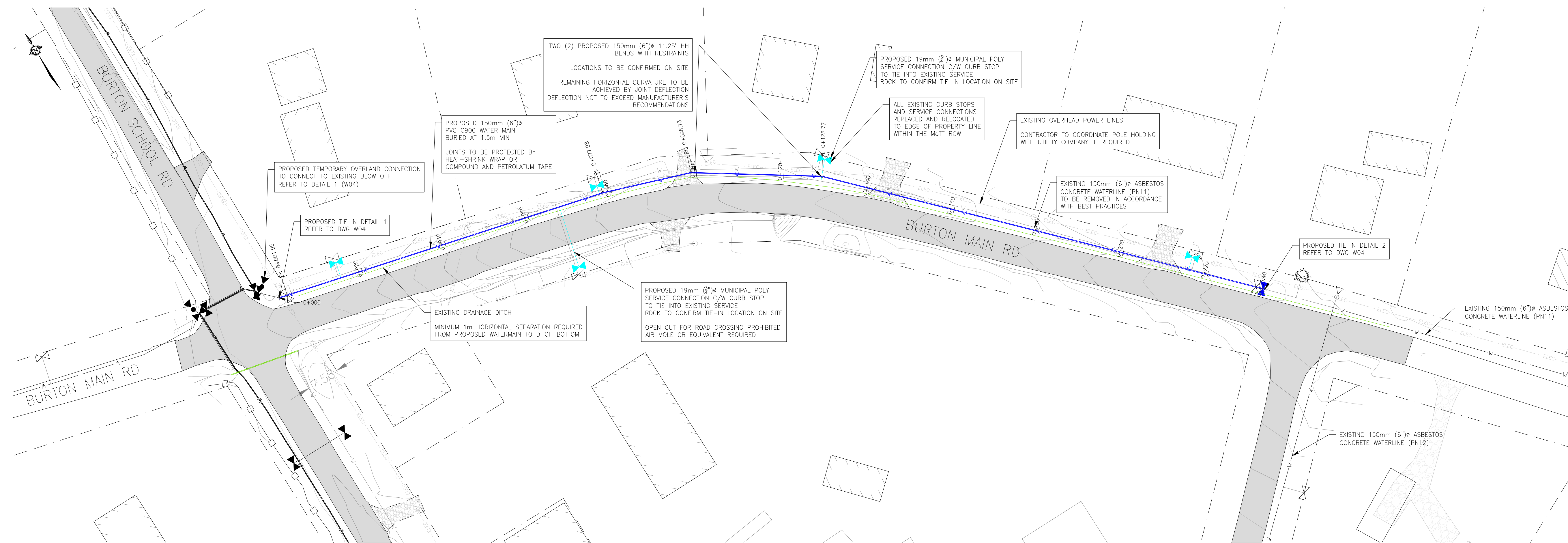

PLAN VIEW (0+000 - 0+233)
SCALE-1:500

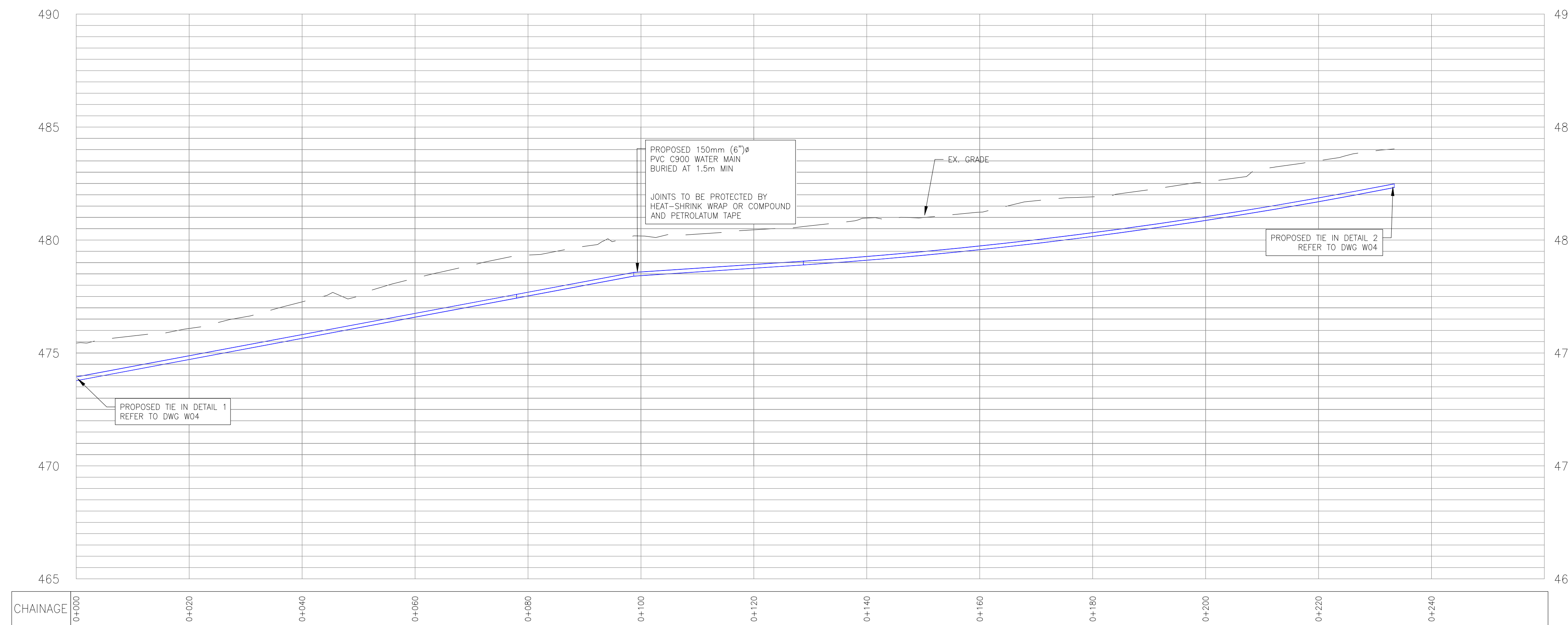

PROFILE VIEW (0+000 - 0+233)
SCALE: H-1:500
V-1:125

- LEGEND:**
- EXISTING WATER VALVE
 - EXISTING HYDRANT
 - EXISTING BLOW OFF
 - EXISTING SAMPLE STATION
 - EXISTING AIR RELEASE VALVE
 - EXISTING WATERMAIN (REMOVED)
 - EXISTING WATER SERVICE
 - EXISTING GAS MAIN
 - WATERMAIN
 - SERVICE CONNECTION
 - WATER VALVE
 - CURB STOP
 - HYDRANT
 - BLOW OFF
 - SAMPLE STATION
 - AIR RELEASE VALVE
 - END CAP
 - CARRIER PIPE

GENERAL NOTES:

ALL DIMENSIONS ARE SPECIFIED IN METERS UNLESS OTHERWISE STATED.

LOT PLAN BASED ON ROCK MAPPING DATA AND SURVEY CARRIED OUT BY CLIENT. HIGHLAND CONSULTING IS NOT LIABLE FOR INACCURACIES IN DRAWING.

SCALE IS BASED ON ARCH EXPANDED D (24"x36") DRAWINGS.

NO VARIATION TO THIS DRAWING SHALL BE PERMITTED UNLESS AUTHORIZED BY ENGINEER IN WRITING.

AERIAL IMAGERY FROM ROCK MAPPING IMPORTED OCTOBER 22, 2024

REFER TO W03 FOR ADDITIONAL NOTES

REV.	DESCRIPTION	DATE
E	ISSUED FOR TENDER	26-MAR-26
D	ISSUED FOR PERMIT	19-MAR-26
C	ISSUED FOR PERMIT	23-FEB-26
B	90% DD FOR REVIEW	09-FEB-26
A	50% DD FOR REVIEW	23-DEC-25

HIGHLAND CONSULTING LTD
CIVIL ENGINEERING
614 Josephine St.
Nelson, BC
V1L 1W7
Canada
C 250 551 1416
pkernan@highlandconsultingltd.com

This drawing not to be used for construction purposes until noted and dated "Issued for Construction". All measurements must be checked on site and be verified with the drawings by Contractor.

Copyright reserved. This drawing and design is and at all times remains the exclusive property of Highland Consulting and cannot be used without their written consent. The information contained herein is for use of the client only. Highland Consulting is not liable to any other parties relating to the use of this drawing.

SEAL

PROJECT TITLE
BURTON WATER SYSTEM UPGRADE PN11

DRAWING TITLE
PLAN & PROFILE (0+000 - 0+233)

CLIENT NAME
RDCK

SCALE: REFER TO DWG	JOB No. 24735
DRAWN: JH	REVISION
CHECKED: PK	DWG. No.
DATE: 26-Mar-26	W02
PLOT: 26-Mar-26	

ISSUED FOR TENDER

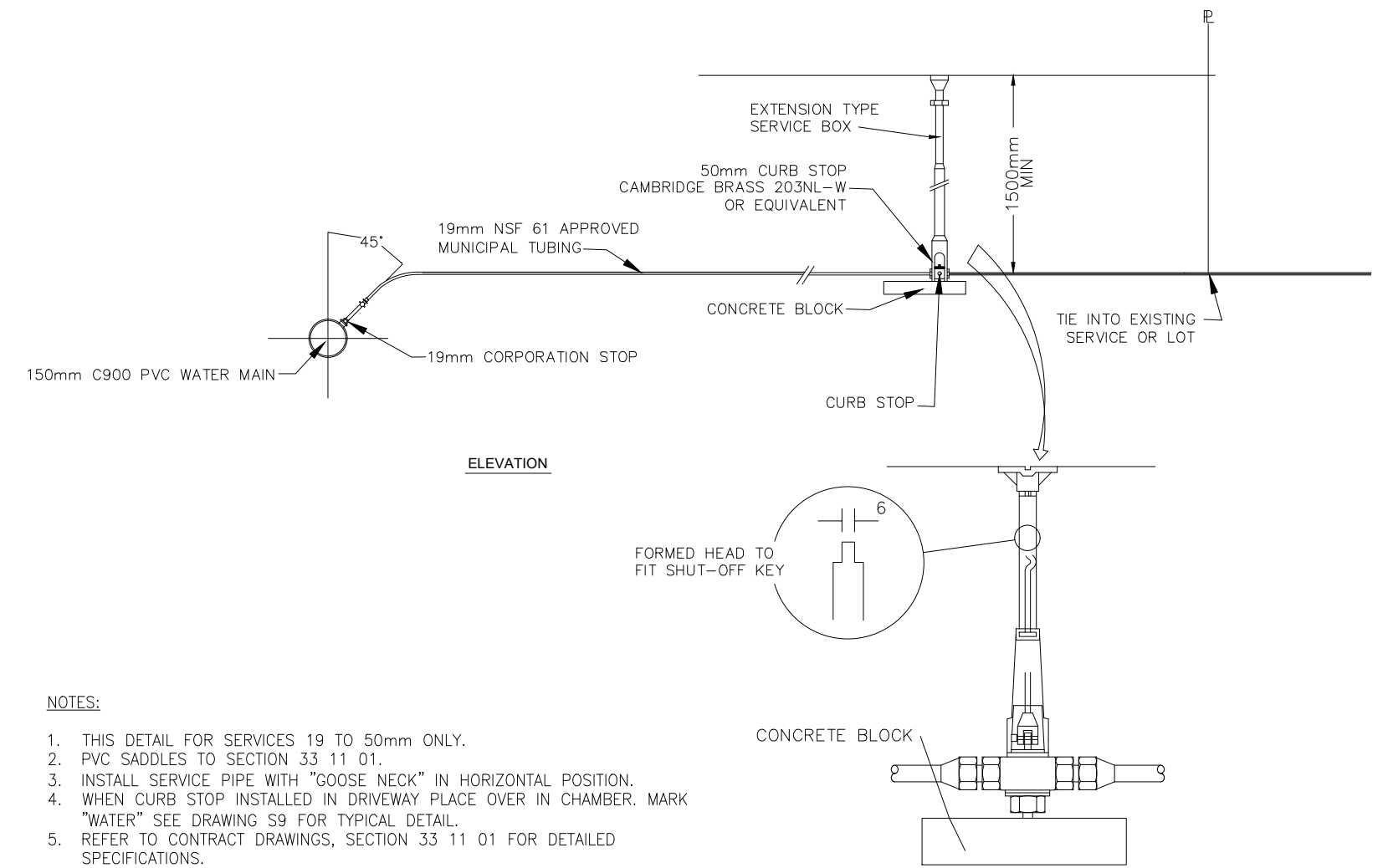

WATER SERVICE CONNECTION – DETAIL
SCALE-NTS

- NOTES:**
1. THIS DETAIL FOR SERVICES 19 TO 50mm ONLY.
 2. PVC SADDLES TO SECTION 33 11 01.
 3. INSTALL SERVICE PIPE WITH "GOOSE NECK" IN HORIZONTAL POSITION.
 4. WHEN CURB STOP INSTALLED IN DRIVEWAY PLACE OVER IN CHAMBER, MARK "WATERS" SEE DRAWING 59 FOR TYPICAL DETAIL.
 5. REFER TO CONTRACT DRAWINGS, SECTION 33 11 01 FOR DETAILED SPECIFICATIONS.

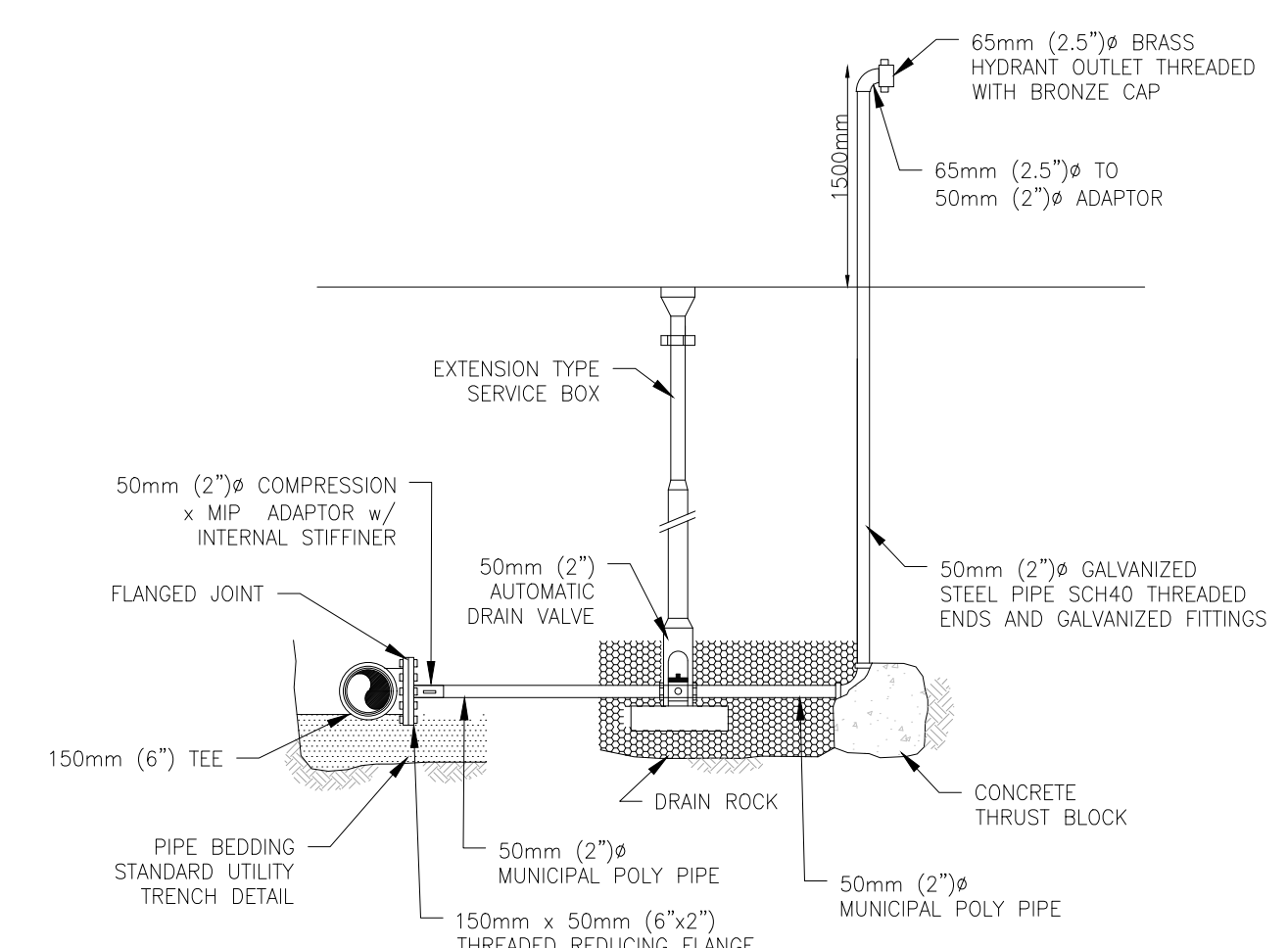

BLOW OFF – DETAIL
SCALE-NTS

WATER NOTES:

1. EXISTING WATER TO BE KEPT IN OPERATION THROUGHOUT PROJECT. CONTRACTOR TO SUPPLY TEMPORARY WATER WHERE REQUIRED TO INSTALL PROPOSED WATERMAIN REPLACEMENT
2. HYDRANTS ARE TO BE INSTALLED PER MMCD STANDARD DETAIL W4, INCLUDING TEES, VALVES AND THRUST BLOCKS (NOT SHOWN ON DRAWINGS).
3. GATE VALVES TO BE SUPPLIED AND INSTALLED PER MMCD 33 11 01 SECTION 2.3. MAX SPACING BETWEEN VALVES IS 200m.
4. WATER SERVICES TO THE RESIDENCES SHALL BE MAINTAINED THROUGHOUT CONSTRUCTION PERIOD EXCEPT FOR A SHORT DURATION DURING TIE-INS. THE MAXIMUM ALLOWABLE WATER SHUT-OFF PERIOD DURING THIS TIME IS 8HRS. CONTRACTOR SHALL PROVIDE NOTICES TO RESIDENCES 48 HOURS PRIOR TO WATER SHUTDOWN. MATERIAL OF SERVICES ARE UNKNOWN BUT EXPECTED TO VARY. CONTRACTOR TO CONFIRM MATERIAL OF SERVICES.
5. COORDINATE WITH REGIONAL DISTRICT OF CENTRAL KOOTENAY TO OPERATE ALL LINE VALVES. CONTRACTOR SHALL NOT OPERATE VALVES.
6. CONTRACTOR TO BE RESPONSIBLE FOR DISINFECTION AND TESTING. DISINFECTION AND TESTING TO BE DONE ACCORDING TO MMCD 33 11 01. AND A REPRESENTATIVE OF THE CLIENT SHALL BE PRESENT. CONTRACTOR TO PROVIDE 72 HOURS NOTICE PRIOR TO TESTING AND DISINFECTION
7. PRESSURE AND LEAKAGE TESTING IN ACCORDANCE WITH AWWA. DISINFECTION IN ACCORDANCE TO C651 AWWA. CHLORINE SOLUTIONS SHALL BE NEUTRALIZED IN ACCORDANCE WITH MINISTRY OF THE ENVIRONMENT AND DEPARTMENT OF FISHERIES AND OCEAN PRIOR TO ANY DRAINAGE COURSE.
8. MINIMUM SEPARATION BETWEEN A WATERMAIN AND ANY STORM INFRASTRUCTURE OR SANITARY SEWER OR MANHOLE SHALL BE 3.0m HORIZONTALLY AND 0.45m VERTICALLY, MEASURED FROM EDGE OF PIPE TO EDGE OF PIPE. WATERMANS SHALL BE LOCATED ABOVE SEWER MAINS.
 - 8.1. WHERE THE REQUIRED 3.0m HORIZONTAL SEPARATION CANNOT BE MET, ONE OF THE FOLLOWING MEASURES SHALL BE IMPLEMENTED, AS APPROVED BY THE ENGINEER: USE OF JOINTLESS PIPE; INCREASE PIPE STRENGTH BY ONE CLASS; OR PROVIDE JOINT PROTECTION BY HEAT-SHRINK PLASTIC WRAP OR BY PACKING JOINTS WITH COMPOUND AND WRAPPING WITH PETROLATUM TAPE. IN ALL CASES, HORIZONTAL SEPARATION SHALL NOT BE LESS THAN 1.0m.
 - 8.2. WHERE THE REQUIRED 3.0 m HORIZONTAL SEPARATION AND 0.45 m VERTICAL SEPARATION CANNOT BE MET, THE MEASURES OUTLINED IN CLAUSE 8.1 SHALL BE IMPLEMENTED AND, IN ADDITION, ONE OF THE FOLLOWING MEASURES SHALL BE IMPLEMENTED, AS APPROVED BY THE ENGINEER: A CONTINUOUS HYDRAULIC BARRIER OR A CASING PIPE WITH WATERTIGHT END SEALS.
8. AS PART OF ABANDONMENT OF EXISTING PIPE, CONTRACTOR TO REMOVE VALVE BOXES ON EXISTING LINE.
9. EXISTING ASBESTOS CEMENT PIPE TO BE REMOVED AND DISPOSED OF OFF-SITE. CONTRACTOR TO FOLLOW WORKSAFE BC GUIDELINES.
10. ALL SHUTDOWNS OF THE WATER SYSTEM TO BE COORDINATED WITH THE RDCK. ANY BUILDING THAT HAS FIRE PROTECTION MUST BE NOTIFIED IN ADVANCE AS WELL AS THE FIRE DEPARTMENT.
11. ALL WATERMANS THAT WILL BE ABANDONED ARE TO BE DECOMMISSIONED FOLLOWING CONSTRUCTION OF THE NEW MAIN AND RE-CONNECTION OF ANY SERVICE CONNECTIONS IS REQUIRED.
12. WATERMANS WITH LESS THAN 1.5m OF COVER SHALL BE INSULATED. TO BE CONFIRMED WITH ENGINEER PRIOR TO INSULATING.
13. TRACER WIRE REQUIRED ON ALL SECTIONS OF WATERMAIN. REFER TO DETAIL.

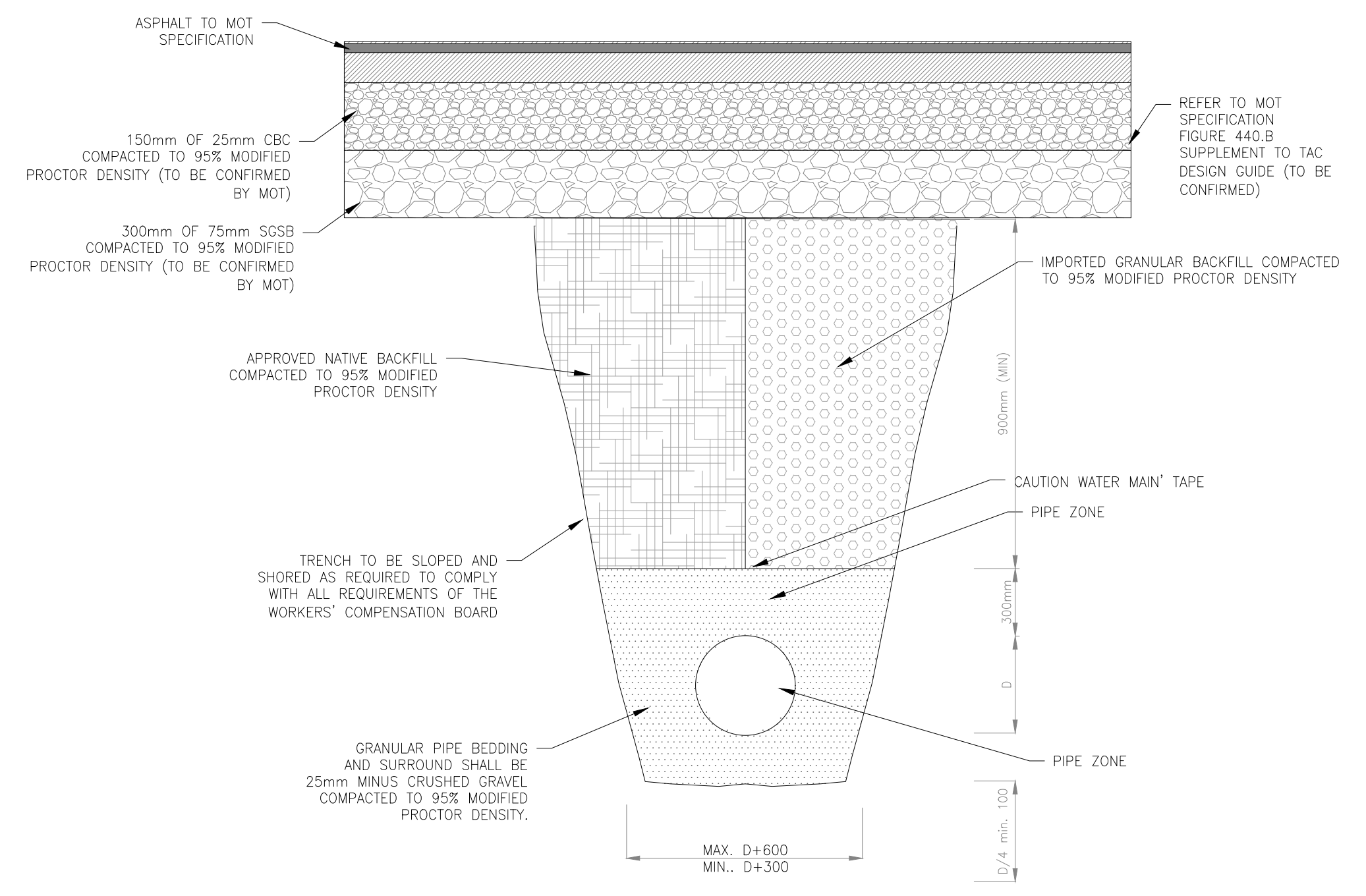

STANDARD CARRIER PIPE TRENCH DETAIL (TYP.)
SCALE-NTS

GENERAL

THIS SPECIFICATION GOVERNS TRACER WIRE INSTALLATION ON WATER MAINS.
EXTRA TRACE WIRE MATERIAL
 TRACE WIRE SHALL BE #14 AWG COPPER WIRE WITH 30 MIL BLUE COLOUR HIGH MOLECULAR WEIGHT POLYETHYLENE INSULATION APPROVED FOR DIRECT BURIAL.
 ALL UNDERGROUND SECTIONS OF WIRE SHALL BE CONTINUOUS (WITHOUT JOINTS OR SPLICES). SURFACE CONNECTION POINTS SHALL BE MADE AT VALVE BOXES OR AT 1.2m LONG, HOT-DIPPED GALVANIZED U-CHANNEL POSTS c/w BLUE PLASTIC MARKERS.

INSTALLATION

TRACE WIRE SHALL BE INSTALLED IN A CONTINUOUS FASHION. INSTALL TRACE WIRE ON TOP OF WATER MAIN AND SECURE TO MAIN EVERY 2m WITH TAPE AS SHOWN IN FIGURE 1.

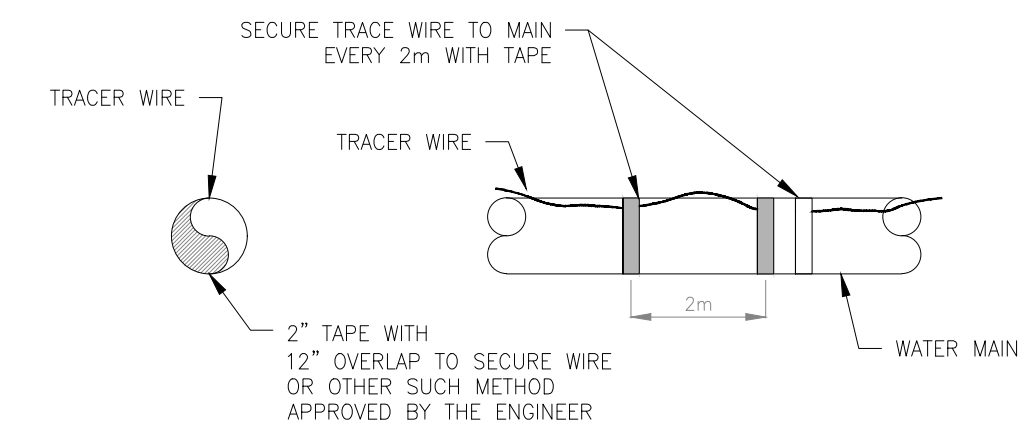

FIGURE 1. TRACER WIRE INSTALLATION

BRING TRACE WIRE TO SURFACE AT EVERY VALVE BOX OR VAULT AS CALLED OUT IN THE DRAWINGS. TRACE WIRE SHALL BE BROUGHT TO THE SURFACE AT LEAST EVERY 300m. TAKE CARE NOT TO DAMAGE THE WIRE COATING. REPAIR DAMAGED COATING WITH ELECTRICAL TAPE.

WHERE TRACER WIRE IS BROUGHT TO THE SURFACE, IT SHALL BE LOCATED OUTSIDE THE PROPOSED TRAIL, ROAD SURFACE AND ROAD SIDE DITCH.

TRACER WIRE – DETAIL
SCALE-NTS

GENERAL NOTES:

1. LOT PLAN BASED ON RDCK MAPPING AND EXISTING RECORD DRAWINGS. HIGHLAND CONSULTING IS NOT LIABLE FOR INACCURACIES IN DRAWINGS. ACTUAL LOCATIONS OF INFRASTRUCTURE TO BE CONFIRMED WITH LAND SURVEY RECORD DRAWINGS. SCALE IS BASED ON ARCH EXPANDED D (24"x36") DRAWINGS.
2. GRADES, DEPTHS AND LOCATIONS OF EXISTING UNDERGROUND UTILITIES ARE APPROXIMATE. BASED ON UNCONFIRMED RECORD INFORMATION. PRIOR TO CONSTRUCTION, CONTRACTOR IS TO VERIFY AND CONFIRM THE SIZE, DEPTH AND MATERIAL OF ALL CROSSING UTILITIES, TIE-INS, CLOSELY ADJACENT UTILITIES (SEE PROFILES, WHICH SHOW UTILITIES WITHIN 1m OF CENTERLINE) AND MAINLINE CONNECTIONS AND REPORT ON ALL SIZE, MATERIAL, LOCATION, AND DEPTHS TO THE CONTRACT ADMINISTRATOR.
3. CONTRACTOR TO PREPARE TRAFFIC AND SAFETY MANAGEMENT PLAN IN ACCORDANCE WITH MMCD SPECIFICATION 01 55 00, AND SUPPLEMENT SPECIFICATION 01 55 00 1.06S, 1.0.7S, AND 1.0.8S
4. ALL CONSTRUCTION AND MATERIALS RELATING TO THE WATER SYSTEM SHALL BE IN ACCORDANCE WITH MASTER MUNICIPAL CONSTRUCTION DOCUMENTS VOLUME II 2019
5. WATER MAIN AND SERVICE CONNECTION MATERIALS SHALL CONFORM TO THE RDCK APPROVED PRODUCTS LIST AND MMCD SECTION 33 11 01. 100 – 300mm DIAMETER WATER MAINS TO BE DUCTILE IRON PRESSURE CLASS 350 TO AWWA C151 OR PVC CLASS 150 AWWA C900 DR18. 350–900mm DIAMETER WATER MAINS TO BE DUCTILE IRON PRESSURE CLASS 250 TO AWWA C151 OR PVC CLASS 150 TO AWWA C905 EXCEPT AS NOTED ABOVE. ALL FITTINGS AND VALVES TO BE DUCTILE IRON (DI) TYTON JOINT WITH CLOSED LUGS UNLESS OTHERWISE SPECIFIED.
6. ALL CURB STOPS TO BE FITTED WITH MUELLER TELESCOPING SERVICE BOXES OR APPROVED EQUIVALENT.
7. RESTORE WORK AREAS AND ALL EXISTING FEATURES TO THEIR ORIGINAL CONDITION OR BETTER.
8. GROUND DISTURBED DURING CONSTRUCTION IS TO BE RESTORED TO EXISTING PER MMCD STANDARD DETAIL G4. DISTURBED SOIL AREAS, INCLUDING DITCHES, ARE TO BE HYDROSEED PER MMCD 32 92 19.
9. DRAWINGS SUBJECT TO CHANGE AND REQUIRES APPROVAL FROM INTERIOR HEALTH.
10. CONTRACTOR RESPONSIBLE FOR COORDINATING WITH UTILITY SERVICES/WORKS IN MOTT RIGHT OF WAY AND OBTAINING NECESSARY APPROVALS.
11. NO VARIATION TO THIS DRAWING SHALL BE PERMITTED UNLESS AUTHORIZED IN WRITING BY ENGINEER.
12. BC ONECALL SHALL BE CONTACTED PRIOR TO ANY EXCAVATION IN THE AREA TO MARK EXISTING UNDERGROUND UTILITIES AND THE CONTRACTOR SHALL NOTIFY ALL APPROPRIATE PARTIES INCLUDING: THE RDCK, TELUS, ROGERS COMMUNICATIONS, BC HYDRO, AND FORTIS GAS PRIOR TO CONSTRUCTION.
13. THE CONTRACTOR SHALL NOTIFY ALL APPROPRIATE PARTIES INCLUDING THE RDCK, TELUS, ROGERS COMMUNICATIONS, BC HYDRO AND FORTIS GAS PRIOR TO CONSTRUCTION.
14. THE CONTRACTOR SHALL MAKE ALL NECESSARY ARRANGEMENTS, IF REQUIRED, FOR THE INSPECTION OF ALL THE REQUIRED UTILITY CONNECTIONS.
15. THE CONTRACTOR SHALL NOTIFY THE CONTRACT ADMINISTRATOR AT LEAST 48HRS IN ADVANCE OF BEGINNING CONSTRUCTION.
16. THE CONTRACTOR SHALL NOTIFY, IN WRITING ALL PROPERTY OWNERS AND/OR RESIDENTS ON A BLOCK BY BLOCK BASIS 7 DAYS IN ADVANCE OF CONSTRUCTION ON THAT BLOCK. SUCH NOTIFICATION SHALL BE AT THE APPROVAL OF THE CONTRACT ADMINISTRATOR.

LEGEND:

- ⊗ – EXISTING WATER VALVE
- ⊕ – EXISTING HYDRANT
- ⊖ – EXISTING BLOW OFF
- – EXISTING SAMPLE STATION
- ⊠ – EXISTING AIR RELEASE VALVE
- — — — — EXISTING WATERMAIN (REMOVED)
- — — — — EXISTING WATER SERVICE
- — — — — EXISTING GAS MAIN
- — — — — WATERMAIN
- — — — — SERVICE CONNECTION
- ⊕ – WATER VALVE
- ⊖ – CURB STOP
- ⊕ – HYDRANT
- ⊖ – BLOW OFF
- – SAMPLE STATION
- ⊠ – AIR RELEASE VALVE
- ⌋ – END CAP
- — — — — CARRIER PIPE

GENERAL NOTES:

ALL DIMENSIONS ARE SPECIFIED IN METERS UNLESS OTHERWISE STATED.
 LOT PLAN BASED ON RDCK MAPPING DATA AND SURVEY CARRIED OUT BY CLIENT. HIGHLAND CONSULTING IS NOT LIABLE FOR INACCURACIES IN DRAWING.
 SCALE IS BASED ON ARCH EXPANDED D (24"x36") DRAWINGS.
 NO VARIATION TO THIS DRAWING SHALL BE PERMITTED UNLESS AUTHORIZED BY ENGINEER IN WRITING.
 AERIAL IMAGERY FROM RDCK MAPPING IMPORTED OCTOBER 22, 2024
 REFER TO W03 FOR ADDITIONAL NOTES

REV.	DESCRIPTION	DATE
E	ISSUED FOR TENDER	26-MAR-26
D	ISSUED FOR PERMIT	19-MAR-26
C	ISSUED FOR PERMIT	23-FEB-26
B	90% DD FOR REVIEW	09-FEB-26
A	50% DD FOR REVIEW	23-DEC-25











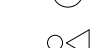





HIGHLAND CONSULTING LTD
 CIVIL ENGINEERING
 614 Josephine St.
 Nelson, BC V1L 1W7
 Canada C 250 551 1416
 pkernan@highlandconsultingltd.com

This drawing not to be used for construction purposes until noted and dated "Issued for Construction". All measurements must be checked on site and to be verified with the drawings by Contractor.
 Copyright reserved. This drawing and design is and at all times remains the exclusive property of Highland Consulting and cannot be used without their written consent. The information contained herein is for use of the client only. Highland Consulting is not liable to any other parties relating to the use of this drawing.

PROJECT TITLE	
BURTON WATER SYSTEM UPGRADE PN11	
DRAWING TITLE	
GENERAL NOTES & DETAILS	
CLIENT NAME	
RDCK	
SCALE: REFER TO DWG	JOB NO: 24735
DRAWN: JH	REVISION
CHECKED: PK	DWG. No.
DATE: 26-Mar-26	W03
PLOT: 26-Mar-26	

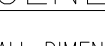
ISSUED FOR TENDER

LEGEND:

-  - EXISTING WATER VALVE
-  - EXISTING HYDRANT
-  - EXISTING BLOW OFF
-  - EXISTING SAMPLE STATION
-  - EXISTING AIR RELEASE VALVE
-  - EXISTING WATERMAIN (REMOVED)
-  - EXISTING WATER SERVICE
-  - EXISTING GAS MAIN
-  - WATERMAIN
-  - SERVICE CONNECTION
-  - WATER VALVE
-  - CURB STOP
-  - HYDRANT
-  - BLOW OFF
-  - SAMPLE STATION
-  - AIR RELEASE VALVE
-  - END CAP
-  - CARRIER PIPE

GENERAL NOTES:

ALL DIMENSIONS ARE SPECIFIED IN METERS UNLESS OTHERWISE STATED.

LOT PLAN BASED ON ROCK MAPPING DATA AND SURVEY CARRIED OUT BY CLIENT. HIGHLAND CONSULTING IS NOT LIABLE FOR INACCURACIES IN DRAWING.

SCALE IS BASED ON ARCH EXPANDED D (24"X36") DRAWINGS.

NO VARIATION TO THIS DRAWING SHALL BE PERMITTED UNLESS AUTHORIZED BY ENGINEER IN WRITING.

AERIAL IMAGERY FROM ROCK MAPPING IMPORTED OCTOBER 22, 2024

REFER TO W03 FOR ADDITIONAL NOTES

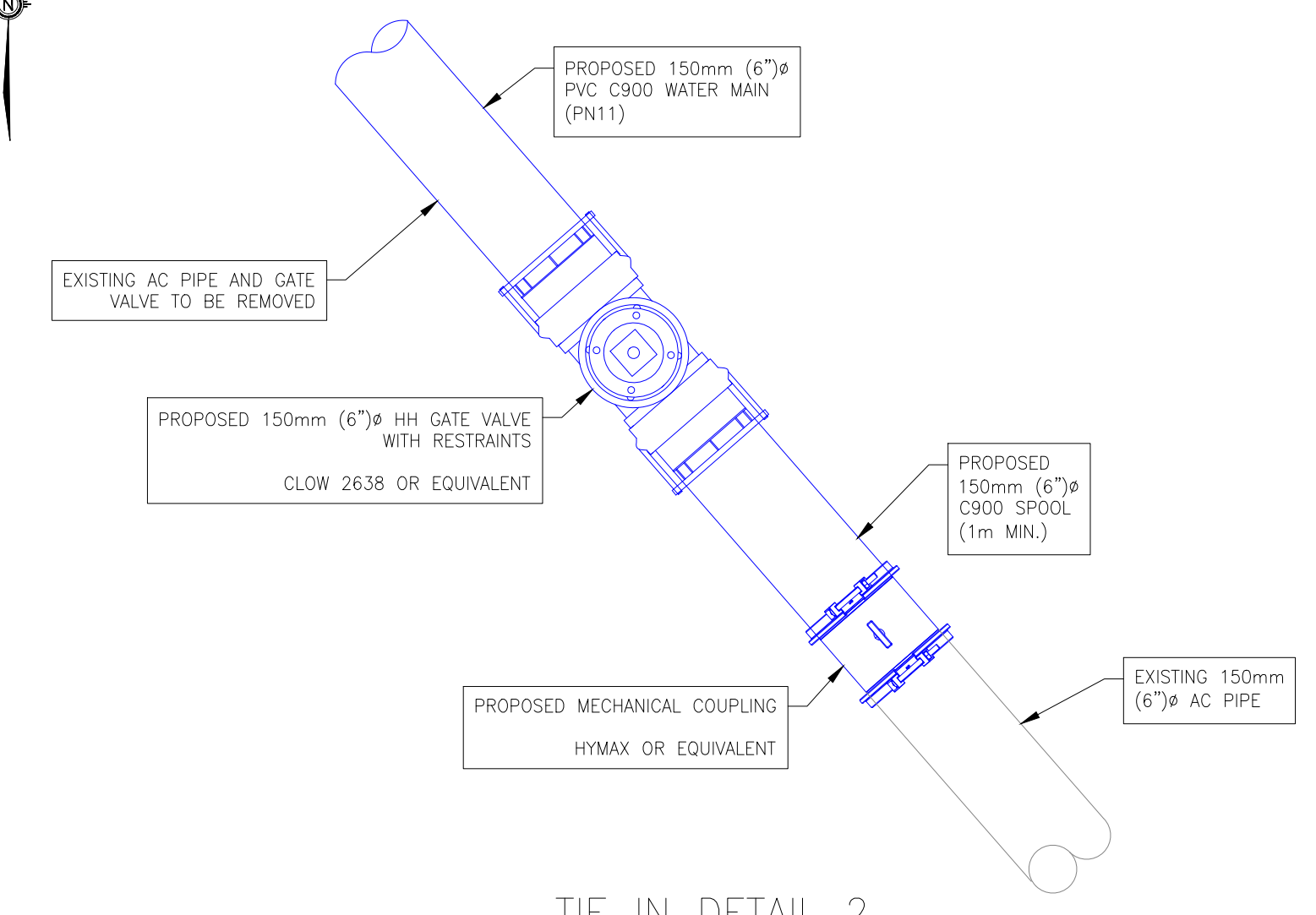

TIE IN DETAIL 2
SCALE-1:10

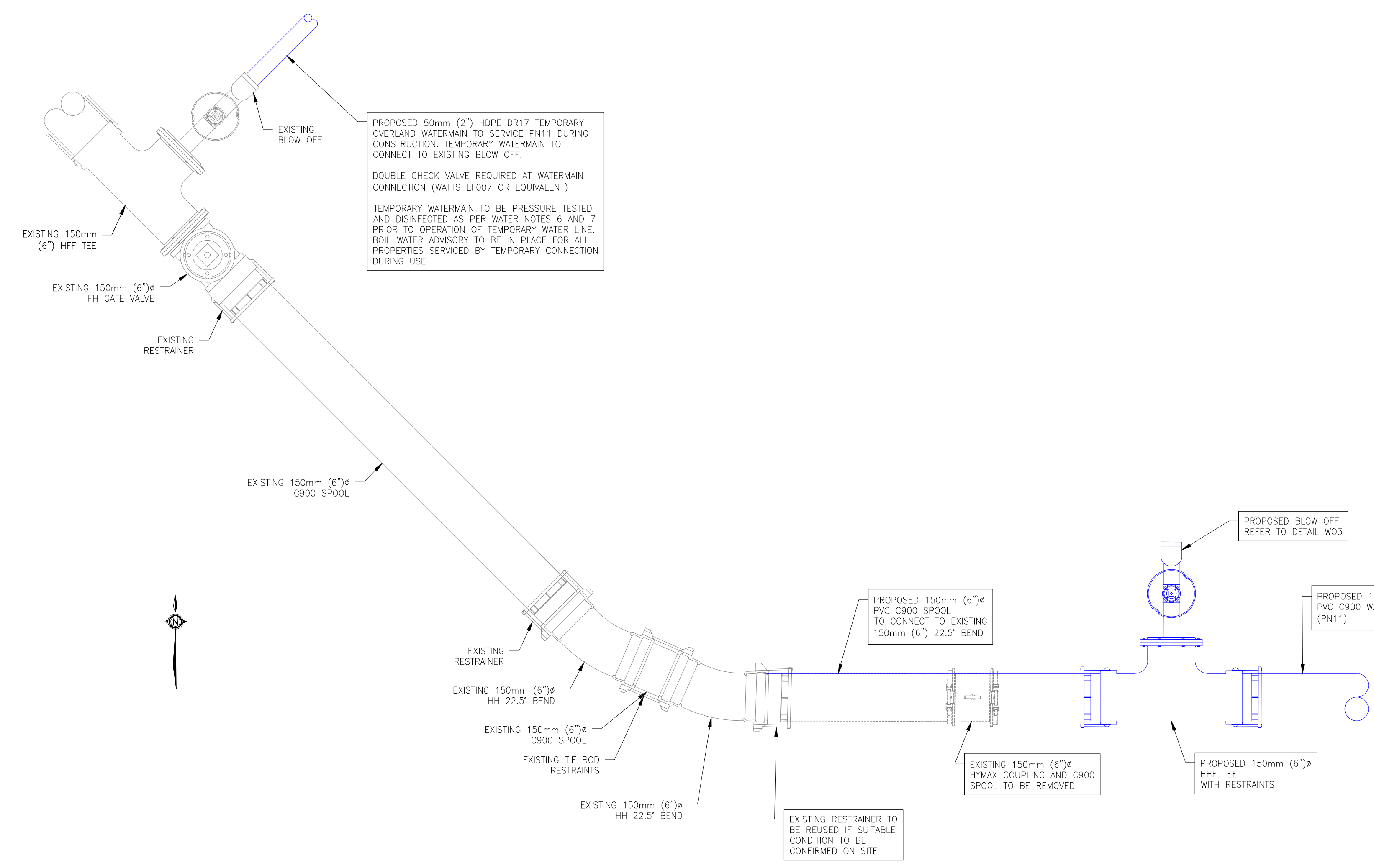

TIE IN DETAIL 1
SCALE-1:10

REV.	DESCRIPTION	DATE
E	ISSUED FOR TENDER	26-MAR-26
D	ISSUED FOR PERMIT	19-MAR-26
C	ISSUED FOR PERMIT	23-FEB-26
B	90% DD FOR REVIEW	09-FEB-26
A	50% DD FOR REVIEW	23-DEC-25

HIGHLAND CONSULTING LTD
CIVIL ENGINEERING

614 Josephine St.
Nelson, BC
V1L 1W7
Canada

C 250 551 1416
pkernan@highlandconsultingltd.com

This drawing not to be used for construction purposes until noted and dated "Issued for Construction". All measurements must be checked on site and be verified with the drawings by Contractor.

Copyright reserved. This drawing and design is and at all times remains the exclusive property of Highland Consulting and cannot be used without their written consent. The information contained herein is for use of the client only. Highland Consulting is not liable to any other parties relating to the use of this drawing.

SEAL

PROJECT TITLE
BURTON WATER SYSTEM UPGRADE PN11

DRAWING TITLE
TIE IN DETAILS

CLIENT NAME
RDCK

SCALE: REFER TO DWG	JOB No. 24735
DRAWN: JH	REVISION 
CHECKED: PK	DWG. No.
DATE: 26-Mar-26	W04
PLOT: 26-Mar-26	

ISSUED FOR TENDER